

C-Series

CIRCUIT BREAKER

The C-Series hydraulic-magnetic circuit breakers are ideal for applications that require higher amperage and voltage handling capability in a smaller package. They are available in 1-6 poles, 0.02-100amps, UL Recognized up to 480VAC or 150VDC, UL489 Listed up to 240VAC or 125VDC, with choice of time delays, terminal options, actuator styles and colors. The C-Series employs a unique arc chute design which allows for higher interrupting capacities of up to 10,000 amps. Thermoset glass filled polyester half shell construction provides for increased mechanical and electrical strength. The wiping contacts mechanical linkage, with two step actuation, cleans contacts providing high, positive contact pressure and longer contact life. Available with American Standard or Metric Threaded Stud terminals, or Saddle Clamp screw terminals. The optional mid-trip handle style actuator allows a visual indication of electrical overload with or without alarm feature.



Product Highlights:

- Extensive list of Agency Approvals
- Available with Standard or Metric Stud terminals, or Saddle Clamp screw terminals
- Optional mid-trip handle style actuator
- Unique arc chute design which allows for higher interrupting capacities of up to 10,000 amps
- Exclusive Rockerguard and Push-To-Reset bezel
- Available with new solid color and two-color Visi-rocker® actuators
- New thermoset glass filled polyester half shell construction

Typical Applications:

- Marine
- Telecom/Datacom
- Military
- Renewable Energy
- Generators & Welders



Electrical

Maximum Voltage	AC, 480 WYE/277 VAC, 50/60 Hz (see Table A.) UL489: AC,240 VAC. (See Table D), 50/60 Hz, 125 VDC
Current Rating	Standard current coils: 0.100, 0.250, 0.500, 0.750, 1.00, 2.50, 5.00, 7.50, 10.0, 15.0, 25.0, 30.0, 35.0, 40.0, 50.0, 60.0, 70.0, 80.0, 90.0 and 100 amps. Other ratings available, see Ordering Scheme.
Standard Voltage Coils	DC - 6V, 12V; AC - 120V; other ratings available, see Ordering Scheme.
Auxiliary Switch Rating	SPDT; 10.1 amps-250VAC, DC Aux. Switch 1.0A, 65 VDC. 0.5A, 80VDC,1/4 HP, 125VAC,VDE & TUV 1.0 125 VAC.
Insulation Resistance	Minimum of 100 Megohms at 500 VDC.
Dielectric Strength	UL, CSA: 1960 V 50/60 Hz for one minute between all electrically isolated terminals. C-Series Circuit Breakers comply with the 8mm spacing and 3750V 50/60 Hz dielectric requirements from hazardous voltage to operator accessible surfaces, between adjacent poles and from main circuits to auxiliary circuits per Publications EN 60950 and VDE 0805.
Resistance, Impedance	Values from Line to Load Terminal - based on Series Trip Circuit Breaker.

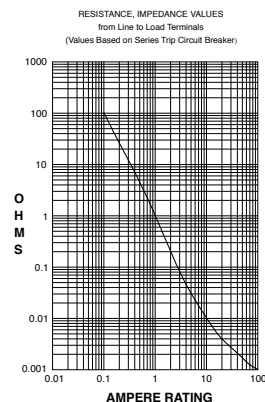

CURRENT (AMPS)	TOLERANCE (%)
0.10 - 5.0	15
5.1 - 20.0	25
20.1 - 50.0	35

Pulse Tolerance Curves

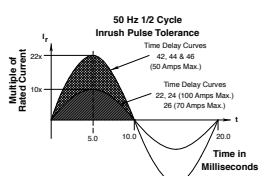
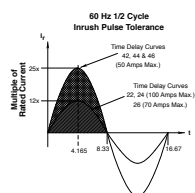

*Manufacturer reserves the right to change product specification without prior notice.

Mechanical

Endurance	10,000 ON-OFF operations @ 6 per minute; with rated current & voltage.
Trip Free	All C-Series circuit breakers will trip on overload, even when actuator is forcibly held in the ON position.
Trip Indication	The operating actuator moves positively to the OFF position when an overload causes the breaker to trip. With mid-trip, handle moves to the mid position on electrical trip of the circuit breaker. With mid trip handle with alarm switch, handle moves to the mid position and the alarm switch actuates when the circuit breaker is electrically tripped.

Physical

Number of Poles	1-6 poles ≤ 50A; 1-4 poles @ 51-70A; 1-2 poles 71-100A. UL489 Handle: 1 pole ≤ 100A, 2 pole ≤ 50A; Rocker: 1 pole ≤ 100A.
Internal Circuit Config.	Series (with or without auxiliary switch, mid trip & mid trip with alarm switch) Shunt & Relay with current or voltage trip coils, Dual Coil, Switch Only (with or without aux. switch). UL489: Series (with or without auxiliary switch, mid-trip & midtrip with alarm switch).
Weight	Approx. 112 grams/pole (3.95 oz).
Standard Colors	Housing: Black

Environmental

Designed and tested in accordance with requirements of specification MIL-PRF-55629 & MIL-STD-202 as follows:	
Shock	Withstands 100 Gs, 6ms sawtooth while carrying rated current per Method 213, Test Condition "I". Instantaneous and ultrashort curves tested @ 90% of rated current.
Vibration	Withstands 0.060" excursion from 10-55 Hz & 10 Gs 55-500 Hz, @ rated current per Method 204C, Test Cond. A. Instantaneous & ultrashort curves tested @ 90% of rated current.
Moisture Resistance	Method 106D, i.e., ten 24-hour cycles @ +25°C to +65°C, 80-98% RH.
Salt Spray	Method 101, Condition A (90-95% RH @ 5% NaCl Solution, 96 hrs).
Thermal Shock	Method 107D, Condition A (five cycles @ -55°C to +25°C to +85°C to +25°C).
Operating Temperature	-40°C to +85°C

Electrical Tables

Table A: Lists UL Recognized & CSA Accepted configurations and performance capabilities as a component supplementary protector

C-SERIES TABLE A: Component Supplementary Protectors												
Circuit Configuration	Voltage			Current Rating		Short Circuit Capacity (Amps)		Application Codes		Construction Notes		
	Max. Rating	Frequency	Phase	Full Load Amps	General Purpose Amps	UL / CSA		UL	CSA			
						With Backup Fuse	Without Backup Fuse					
Series	32	DC	---	0.02 - 100	---	---	5,000	TC1, OL1, U2	TC1, OL1, U2	---		
	48	DC	---	110 - 150	---	---	5,000			---		
	65	DC	---	0.02 - 70	---	71 - 100	---	5,000	TC1, 2, OL1, U1	TC1, 2, OL1, U1	---	
				-	---				TC1, 2, OL0, U1	TC1, 2, OL0, U1	---	
	80	DC	---	0.02 - 70	---	71 - 100	---	7,500	TC1, 2, OL1, U1	TC1, 2, OL1, U1	---	
				---	---				TC1, 2, OL0, U1	TC1, 2, OL0, U1	---	
				0.02 - 70	---				10,000	TC1, 2, OL1, U1	TC1, 2, OL1, U1	Must have Agency "L"
	---	71 - 100	TC1, 2, OL0, U1	TC1, 2, OL0, U1								
	125	DC	---	0.02 - 50	---	---	5,000	TC1, 2, OL1, U1	TC1, 2, OL1, U1	Must have Agency "L"		
	125/250	DC	---	0.02 - 50	---	---	5,000	TC1, 2, OL1, U1	TC1, 2, OL1, U1	Must have Agency "L"		
	250	DC	---	0.02 - 50	---	---	5,000	TC1, 2, OL1, U1	TC1, 2, OL1, U1	Must have Agency "L": 250 volts requires 2 pole		
	125	50 / 60	1	0.02 - 100	---	---	---	3,000	TC1, OL1, U2	TC1, OL1, U2	Per pole rating	
								5,000	TC1, 2, OL1, U1	TC1, 2, OL1, U1	Must have Agency "L"	
	150	DC	---	---	---	80 - 100	---	5,000	TC1, 2, OL0, U3	---	Must have Agency "L"	
											101 - 175	---
	125/250	50 / 60	1	0.02 - 100	---	---	---	3,500	TC1, OL1, U2	TC1, OL1, U2	---	
				0.02 - 50				---	3,000	TC1, 2, OL1, U1	TC1, 2, OL1, U1	2 or 3 poles breaking single phase
				51 - 100				---	1,000	TC1, 2, OL1, U1	TC1, 2, OL1, U1	2 or 3 poles breaking single phase
				0.02 - 100				---	5,000	TC1, 2, OL1, U2	TC1, 2, OL1, U2	2 or 3 poles breaking single phase. Agency "L"
	250	50 / 60	1	0.02 - 50	---	---	---	3,500	TC1, 2, OL1, U2	TC1, 2, OL1, U2	Per pole rating	
				0.02 - 100				---	5,000	TC1, 2, OL1, U1	TC1, 2, OL1, U1	Must have Agency "L"
				51 - 70				---	5,000	TC1, 2, OL1, C1	TC1, 2, OL1, C1	---
			---	0.02 - 100				---	3,000	TC1, 2, OL0, U2	TC1, 2, OL0, U2	---
			---	---				3	0.02 - 70	---	5,000	---
---	---	---	0.02 - 90	---	5,000	---	TC1, 2, OL0, U1	TC1, 2, OL0, U1	Must have Agency "L"			
277	50 / 60	1	0.02 - 50	---	---	5,000	---	TC1, 2, OL1, C1	TC1, 2, OL1, C1	---		
480/277	50 / 60	3	0.02 - 30	---	---	5,000	---	TC1, 2, OL1, C1	TC1, 2, OL1, C1	3 poles breaking 3 phase		
			---	---	---	---	---	TC1, 2, OL0, C1	TC1, 2, OL0, C1	---		
480	50 / 60	1	0.02 - 30	---	---	5,000	---	TC1, 2, OL1, C1	TC1, 2, OL1, C1	2 poles breaking 1 phase		
			---	---	---	---	---	TC1, 2, OL0, C1	TC1, 2, OL0, C1	---		
Dual Coil	80	DC	---	0.02 - 50	---	---	7,500	TC1, 2, OL1, U1	TC1, 2, OL1, U1	---		
	125	50 / 60	1	0.02 - 50	---	---	3,000	TC1, OL1, U2	TC1, OL1, U2	Per pole rating		
	125/250	50 / 60	1	0.02 - 50	---	---	---	3,500	TC1, OL1, U2	TC1, OL1, U2	2 or 3 poles breaking single phase	
								3,000	TC1, 2, OL1, U1	TC1, 2, OL1, U1	2 or 3 poles breaking single phase	
	250	50 / 60	1	0.02 - 50	---	---	---	3,500	TC1, OL1, U2	TC1, OL1, U2	---	
3			---					3,000	TC1, OL0, U2	TC1, OL0, U2	Per pole rating	
277	50 / 60	1	0.02 - 50	---	---	5,000	---	TC1, 2, OL1, C1	TC1, 2, OL1, C1	3 poles breaking 3 phase		
Shunt	80	DC	---	0.02 - 50	---	---	7,500	TC1, 2, OL1, U1	TC1, 2, OL1, U1	---		
	277	50 / 60	1	0.02 - 50	---	---	5,000	---	TC1, 2, OL1, C1	TC1, 2, OL1, C1	---	
	250	50 / 60	3	0.02 - 50	---	---	---	5,000	---	TC1, 2, OL1, C1	TC1, 2, OL1, C1	3 poles breaking 3 phase
								---	---	---	---	---
	480/277	50 / 60	3	0.02 - 30	---	---	5,000	---	TC1, 2, OL1, C1	TC1, 2, OL1, C1	---	
---				31 - 50	---	---	---	TC1, 2, OL0, C1	TC1, 2, OL0, C1	---		
480	50 / 60	1	0.02 - 30	---	---	5,000	---	TC1, 2, OL1, C1	TC1, 2, OL1, C1	2 poles breaking 1 phase		
			---	31 - 50	---	---	---	TC1, 2, OL0, C1	TC1, 2, OL0, C1	---		
Relay	80	DC	---	0.02 - 50	---	---	7,500	TC1, 2, OL1, U1	TC1, 2, OL1, U1	---		
	277	50 / 60	1	0.02 - 50	---	---	5,000	---	TC1, 2, OL1, C1	TC1, 2, OL1, C1	---	
	250	50 / 60	3	0.02 - 50	---	---	5,000	---	TC1, 2, OL1, C1	TC1, 2, OL1, C1	3 poles breaking 3 phase	
Switch Only	65	DC	---	71 - 100	---	---	---	---	---	---		
				---	---	---	---	---	---			
	80	DC	---	71 - 100	---	---	---	---	---	---		
				---	---	---	---	---	---			
	125	50 / 60	1	0.02 - 100	---	---	---	---	---	---		
	125/250	50 / 60	1	0.02 - 100	---	---	---	---	---	---	2 or 3 poles breaking single phase	
---			---	---	---	---	---	---	---	---		
250	50 / 60	1	0.02 - 100	---	---	---	---	---	---	---		
		3	0.02 - 70	---	---	---	---	---	---	---		
277	50 / 60	1	0.02 - 50	---	---	---	---	---	---			
480/277	50 / 60	3	0.02 - 30	---	---	---	---	---	---	3 poles breaking 3 phase		
			---	---	---	---	---	---	---	---		

Notes:
 1. Requires branch circuit backup with a UL LISTED Type K5 or RK5 fuse rated 15A minimum and no more than 4 times full load amps not to exceed 125A for 50 Amp or less rating and not to exceed 175 for 51 through 100 Amp rating

Electrical Tables

Table B: Lists UL Recognized and CSA Accepted configurations and performance capabilities as a Manual Motor Controller.

C-SERIES TABLE B: Manual Motor Controllers					
Circuit Configuration	Voltage			Current Rating	Horsepower Ratings
	Max. Rating	Frequency	Phase	Full Load Amps	Max. HP
Series, Shunt & Relay Switch Only	120 ¹	50 / 60	1	0.02 - 50	7 1/2
	250 ¹	50 / 60	1	0.02 - 20	3
			3	0.02 - 20	5
	277 ¹	50 / 60	1	0.02 - 20	3
480 ²	50 / 60	3	0.02 - 20	5	

- Notes:
- Requires branch circuit backup with a UL Listed Type K5 or RK5 fuse rated 15A Minimum and no more than 4 times full load amps not to exceed 125A for 50 Amp or less rating and not to exceed 175A for 51 through 100A rating.
 - UL Recognized and CSA Certified at 480V refers to 3 and 4 pole versions used in a 3Ø, WYE connected circuit or a 2 pole version with 2 poles breaking 1Ø and backed up with a series fusing as stated in note 1.
- * Shunt and Relay Trip - Voltage Coil Construction not current coils

Table C: Lists UL Recognized, CSA Accepted, VDE and TUV Certified configurations and performance capabilities as a Component Supplementary Protector.

C-SERIES TABLE C: Component Supplementary Protectors															
Circuit Configuration	Voltage			Current Rating		Short Circuit Capacity (Amps)						Application Codes UL / CSA	Construction Notes		
	Max. Rating	Frequency	Phase	Full Load Amps	General Purpose Amps ¹	UL / CSA		VDE		TUV					
						With Backup Fuse	Without Backup Fuse	(Inc) With Backup Fuse	(Inc) Without Backup Fuse	(Inc) With Backup Fuse	(Inc) Without Backup Fuse				
Series	80	DC	---	0.10 - 70	---	---	7,500	---	5,000	5,000	1,500	TC1,2,OL1,U1	---		
				71 - 100	71 - 100	---	10,000	---	5,000	---	5,000	TC1,2,OL0,U1	Agency F, H, J or R		
	250	50 / 60	1	0.10 - 50	---	---	---	---	---	---	5,000	---	2P, Agency J or R		
				0.10 - 70	---	---	5,000	---	---	3,000	1,500	3,000	1,500	TC1,2,OL1,U1	---
				0.10 - 100	---	---	---	---	---	---	---	---	5,000	5,000	Agency J or R
				0.10 - 90	---	---	---	---	---	---	---	---	---	---	---
415	50 / 60	3	0.10 - 30	---	5,000 ²	---	---	3,000	1,500	3,000	1,500	TC1,2,OL1,C1	Rocker		
								5,000	2,500				Handle, Agency F, H, J or R		
Dual Coil	80	DC	---	0.10 - 30	---	---	7,500	---	1,500	5,000	1,500	TC1,2,OL1,U1	---		
	250	50 / 60	1 & 3							5,000				3,000	3,000
Shunt	80	DC	---	0.10 - 70	---	---	7,500	---	5,000	5,000	1,500	TC1,2,OL1,U1	---		
	250	50 / 60	1 & 3	0.10 - 70	---	---	5,000	3,000	1,500	3,000	1,500	TC1,2,OL1,U1	---		
	415	50 / 60	3	0.10 - 30	---	5,000 ²	---	3,000	1,500	3,000	1,500	TC1,2,OL1,C1	Rocker		
5,000	2,500	Handle, Agency F, H, J or R													

- Notes:
- General Purpose ratings for UL/CSA only.
 - Requires branch circuit backup with a UL LISTED Type K5 or RK5 fuse rated 15A minimum and no more than 4 times full load amps not to exceed 125A for 50 Amp or less rating and not to exceed 175 for 51 through 100 Amp rating.

Table D: Lists UL Listed (489), CSA Certified (C22.2 No. 5.1-M) configuration and performance capabilities as a Molded Case Circuit Breaker.

C-SERIES TABLE D: UL489 Listed Branch Circuit Breakers							
Circuit Configuration	Voltage			Current Rating	Interrupting Capacity (Amps)		Construction Notes
	Max. Rating	Frequency	Phase	Full Load Amps	Without Backup Fuse		
Series	80	DC	---	0.10 - 100	50,000 ¹		Limited to 2 Poles Max from 71 - 100 Amps
					10,000		
				101 - 150		10,000	
	125	DC	---	0.10 - 100	10,000		3 Poles - Parallel Poles
					5,000		1 - 3 Poles
	125 / 250	DC	---	0.10 - 50	5,000		1 or 2 Poles (2 poles required for 250 Volts)
	120	50 / 60	1	0.10 - 50	10,000		1 - 3 Poles
					5,000		
	120 / 240	50 / 60	1	0.10 - 50	5,000		2 or 3 Poles (1 pole of a 3 pole unit is neutral)
					10,000 ¹		
240	50 / 60	1	0.10 - 30	5,000		1 Pole	
				10,000		2 Poles	
277	50 / 60	1	0.10 - 20	10,000		1 Pole	
Dual Coil	120	50 / 60	1	0.10 - 30	10,000		---

- Notes:
- Special catalog number required. Consult factory.

Electrical Tables

Table E: Lists UL Recognized, CSA Accepted configurations and performance capabilities as Protectors, Supplementary for Marine Electrical and Fuel Systems (Guide PEQZ2, File E75596). Ignition Protected per UL 1500. UL Classified Small Craft Electrical Devices, Marine in accordance with ISO 8846 (Guide UZMK, File MQ1515) as Marine Supplementary Protectors.

C-SERIES TABLE E: UL1500 (Marine Ignition Protection)								
Circuit Configuration	Voltage			Current Rating	Interrupting Capacity (Amps)	Application Codes		Construction Notes
	Max. Rating	Frequency	Phase	Full Load Amps	Without Backup Fuse	UL	CSA	
Series	48	DC	---	0.02 - 100	5,000	TC1, 2, OL1, U1	TC1, 2, OL1, U1	---
				101 - 150				
	65	DC	---	0.02 - 100	1,500	TC1, 2, OL0, U1	TC1, 2, OL0, U1	---
	80	DC	---	0.02 - 70	1,500	TC1, 2, OL1, U1	TC1, 2, OL1, U1	---
	125	50 / 60	1	0.02 - 70	5,000	TC1, 2, OL1, U1	TC1, 2, OL1, U1	---
				71 - 100	1,500			
	250	50 / 60	1	0.02 - 70	1,500	TC1, 2, OL1, U1	TC1, 2, OL1, U1	---
				71 - 100				2 Poles Breaking Single Phase

Table F: Lists UL Listed configurations and performance capabilities as Circuit Breakers for use in Communications Equipment (Guide DITT, File E189195), under UL489A.

C-SERIES TABLE F: PARALLEL POLE CONSTRUCTION UL489A Listed for Communications Equipment				
Circuit Configuration	Voltage		Current Rating	Interrupting Capacity (Amps)
	Max. Rating	Frequency	General Purpose Amps	Without Backup Fuse
Series	80	DC	100 - 250	10,000

Agency Certifications

UL Recognized

UL Standard 1077



Component Recognition Program as Protectors Supplementary (Guide CCN/QVNU2, File E75596)

CSA Accepted



Component Supplementary Protector under Class 3215 30, File 047848 0 000 CSA Standard C22.2 No. 235

UL Standard 508



Switches, Industrial Control (Guide CCN/NRNT2, File E148683)

CSA Certified



Circuit Breaker Model Case (Class 1432 01, File 093910), CSA Standard C22.2 No. 5.1 - M

UL Standard 1500



Protectors, Supplementary for Marine Electrical & Fuel Systems (Guide PEQZ2, File E75596) Ignition Protection

TUV Certified



EN60934, under License No. R72040875

UL Listed

UL Standard 489



Circuit Breakers, Molded Case, (Guide DIVQ, File E129899)

VDE Certified



EN60934, VDE 0642 under File No. 10537

UL Standard 489A



Communications Equipment (Guide CCN/DITT, File E189195)



1 SERIES

C

2 ACTUATOR ¹

- A** Handle, one per pole
- B** Handle, one per multipole unit
- S** Mid-Trip Handle, one per pole
- T** Mid-Trip Handle, one per pole & Alarm Switch

3 POLES ²

- | | | |
|--------------|----------------|---------------|
| 1 One | 3 Three | 5 Five |
| 2 Two | 4 Four | 6 Six |

4 CIRCUIT ³

- | | |
|---|--|
| A ³ Switch Only (No Coil) | F ⁴ Relay Trip (Current) |
| B Series Trip (Current) | G ⁴ Relay Trip (Voltage) |
| C Series Trip (Voltage) | H ^{4,5} Dual Coil with Shunt Trip Voltage Coil |
| D ⁴ Shunt Trip (Current) | K ^{4,5} Dual Coil with Relay Trip Voltage Coil |
| E ⁴ Shunt Trip (Voltage) | |

5 AUXILIARY / ALARM SWITCH

- | | |
|---|-------------------------------------|
| 0 without Aux Switch | 6 S.P.S.T., 0.139 Solder Lug |
| 2 S.P.D.T., 0.110 Q.C. Term. | 8 S.P.S.T., 0.187 Q.C. Term. |
| 3 S.P.D.T., 0.139 Solder Lug | 9 S.P.D.T., 0.187 Q.C. Term. |
| 4 S.P.D.T., 0.110 Q.C. Term. (Gold Contacts) | |

6 FREQUENCY & DELAY

- | | |
|--|--|
| 03 ³ DC 50/60Hz, Switch Only | 30 DC 50/60Hz Instantaneous |
| 10 ⁷ DC Instantaneous | 31 DC 50/60Hz Ultra Short |
| 11 DC Ultra Short | 32 DC 50/60Hz Short |
| 12 DC Short | 34 DC 50/60Hz Medium |
| 14 DC Medium | 36 DC 50/60Hz Long |
| 16 DC Long | 42 ⁸ 50/60Hz Short, Hi-Inrush |
| 20 ⁷ 50/60Hz Instantaneous | 44 ⁸ 50/60Hz Medium, Hi-Inrush |
| 21 50/60Hz Ultra Short | 46 ⁸ 50/60Hz Long, Hi-Inrush |
| 22 50/60Hz Short | 52 ⁸ DC Short, Hi-Inrush |
| 24 50/60Hz Medium | 54 ⁸ DC Medium, Hi-Inrush |
| 26 50/60Hz Long | 56 DC Long, Hi-Inrush |

Notes:

- 1 Actuator Code:
A: Handle tie pin spacer(s) and retainers provided assembled with multi-pole units.
B: Handle location as viewed from front of breaker:
2 pole - left pole 3 pole - center pole 4 pole - two handles at center poles
5 pole - three handles at center poles 6 pole - four handles at center poles
S: Handle moves to mid-position only upon electrical trip of the breaker. Available with circuit codes B, C, D, E, F, G, H and K.
T: Handle moves to mid-position and alarm switch activates only upon electrical trip of the breaker. Available with circuit codes B & C.
- 2 Standard multipole units have all poles identical except when specifying auxiliary switch and/or mixed poles. 4 pole max with VDE. 5th pole available as Series Trip with Voltage Coil only.
- 3 Switch Only circuits, rated up to 50 amps and 6 poles, and only available with VDE Certification when tied to a protected pole (Circuit Code B, C, D or H.). For .02 to 30 amps, select Current Code 630. For 35 - 50 amps, select Current Code 650. For 55-70 amps, select Current Code 670. For 75-100 amps, select Current Code 810. Circuit Codes D,E,F,G,H & K available with Terminal Codes 1,2,4 & 5 only. Circuit Codes D, F, H & K available up to 50 amps maximum Current Rating.
- 5 Consult factory for available Dual Coil options, as special catalog number is required. Dual Coil Voltage Coils with Shunt Trip Construction trip instantaneously on line voltage. Dual Coil Voltage Coils require 30VA minimum power to trip instantaneously and are rated for intermittent duty only.
- 6 Auxiliary Switch available with Series Trip and Switch Only circuits. On multi-pole breakers, one auxiliary switch is supplied, mounted in the extreme right pole.
- 7 Voltage coils not rated for continuous duty. Available only with delay codes 10 & 20.
- 8 Available with Circuit Codes B & D only, and up to 50 amps maximum.
- 9 Current Ratings 60 - 70 are available up to four poles maximum. Ratings 71 - 100 are available up to two poles maximum.
- 10 Terminal Code 1 available to 60 amps maximum.
- 11 Terminal Codes 2, 4, 5 and C available to 50 amps maximum.
- 12 Terminal Codes 3, 6 & 9 available to 100 amps maximum.
- 13 Terminal Code 7 available to 25 amps maximum.
- 14 Terminal Code A available to 100 amps maximum.
- 15 Terminal Codes 7, 9 & C are not VDE approved.
- 16 No marking available. Consult factory. VDE/TUV Approval requires dual (I-O, ON-OFF) or I-O markings on all handles.
- 17 Single pole only.
- 18 VDE/TUV: 30 amps max.; UL/CSA: 50 amps max.; Available in 2 - 4 poles only and limited to AC Delays. "General Purpose amps" not rated for "full load amps" or to be used in applications with a motor.

7 CURRENT RATING (AMPERES)

CODE	AMPERES	CODE	AMPERES	CODE	AMPERES	CODE	AMPERES
020	0.020	235	0.350	430	3.000	614	14.000
025	0.025	240	0.400	435	3.500	615	15.000
030	0.030	245	0.450	440	4.000	616	16.000
035	0.035	250	0.500	445	4.500	617	17.000
040	0.040	255	0.550	450	5.000	618	18.000
045	0.045	260	0.600	455	5.500	620	20.000
050	0.050	265	0.650	460	6.000	622	22.000
055	0.055	270	0.700	465	6.500	624	24.000
060	0.060	275	0.750	470	7.000	625	25.000
065	0.065	280	0.800	475	7.500	630	30.000
070	0.070	285	0.850	480	8.000	635	35.000
075	0.075	290	0.900	485	8.500	640	40.000
080	0.080	295	0.950	490	9.000	650	50.000
085	0.085	410	1.000	495	9.500	660	60.000
090	0.090	512	1.250	610	10.000	670	70.000
095	0.095	415	1.500	710	10.500	680	80.000
210	0.100	517	1.750	611	11.000	685	85.000
215	0.150	420	2.000	711	11.500	690	90.000
220	0.200	522	2.250	612	12.000	695	95.000
225	0.250	425	2.500	712	12.500	810	100.000
230	0.300	527	2.750	613	13.000		

OR VOLTAGE COIL (NORMAL RATED VOLTAGE) ⁷

CODE	AMPERES	CODE	VOLTS	CODE	VOLTS	CODE	VOLTS
A06	6 DC	A32	32 DC	J12	12 AC	J65	65 AC
A12	12 DC	A48	48 DC	J18	18 AC	K20	120 AC
A18	18 DC	A65	65 DC	J24	24 AC	L40	240 AC
A24	24 DC	J06	6 AC	J48	48 AC		

8 TERMINAL ¹⁵

- | | |
|---------------------------------------|--|
| 1 ¹⁰ Stud 10-32 | 6 ¹² Stud M6 |
| 2 ¹¹ Screw 10-32 | 7 ^{13,15} 0.250 Double Click Connect |
| 3 ¹² Stud 1/4-20 | 9 ¹⁵ 7/16" Clip Terminal |
| 4 ¹¹ Stud M5 x 0.8 | A ¹⁴ Plug-In Stud |
| 5 ¹¹ Screw M5 x 0.8 | C ^{11,15} 5/16" Clip Terminal |

9 ACTUATOR COLOR & LEGEND ¹⁶

Actuator Color	I-O	ON-OFF	Dual	Legend Color
White	A	B	1	Black
Black	C	D	2	White
Red	F	G	3	White
Green	H	J	4	White
Blue	K	L	5	White
Yellow	M	N	6	Black
Gray	P	Q	7	Black
Orange	R	S	8	Black
Black (short handle) ¹⁷	T	U	9	White

10 MOUNTING / BARRIERS

MOUNTING STYLE	BARRIERS	VOLTAGE
Threaded Insert		
1 6-32 x 0.195 inches	no	< 300
A 6-32 X 0.195 inches	yes	< 300
C 18 6-32 X 0.195 inches	yes	≥ 300
2 ISO M3 x 5mm	no	< 300
B ISO M3 x 5mm	yes	< 300
D 18 ISO M3 x 5mm	yes	≥ 300
Front panel Snap-In, 1.00" [25.4mm] wide bezel		
E 17 with Handleguard	no	< 300

11 AGENCY APPROVAL

- C** UL Recognized, CSA Accepted
- D** VDE Certified, UL Recognized, CSA Accepted
- E** TUV Certified, UL Recognized, CSA Accepted
- H** UL489 Construction: VDE Certified, UL Recognized, CSA Accepted
- I** UL Recognized STD 1077, UL Recognized 1500 (ignition protected), CSA Accepted
- L** UL489 Construction: UL Recognized, CSA Accepted
- R** UL489 Construction: TUV Certified, UL Recognized, CSA Accepted

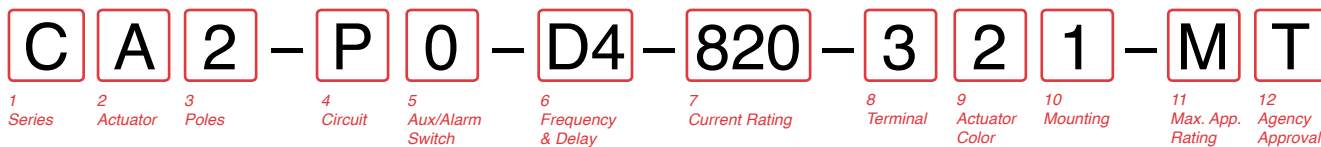

1 SERIES
C

2 ACTUATOR
A Handle, one per pole
S Mid-Trip Handle, one per pole ¹
T Mid-Trip, one per pole & Alarm Switch ¹

3 POLES ⁴
1 One
2 Two
3 Three

4 CIRCUIT
P Series Trip (parallel pole)

5 AUXILIARY / ALARM SWITCH
0 without Aux Switch 6 S.P.S.T., 0.139 Solder Lug
2 S.P.D.T., 0.110 Q.C. Term. 7 S.P.S.T., 0.110 Q.C
3 S.P.D.T., 0.139 Solder Lug Term. (Gold Contacts)
4 S.P.D.T., 0.110 Q.C. Term. 8 S.P.S.T., 0.187 Q.C. Term.
(Gold Contacts) 9 S.P.D.T., 0.187 Q.C. Term.
5 S.P.S.T., N.O., 0.110 Q.C
Term. (Gold Contacts)

6 FREQUENCY & DELAY
D1 DC Ultra Short
D2 DC Short
D4 DC Medium
D6 DC Long

7 CURRENT RATING (AMPERES) ⁴

CODE	AMPERES				
810	100.00	813	130.00	817	170.00
811	110.00	814	140.00	818	180.00
812	120.00	815	150.00	819	190.00
813	130.00			820	200.00
814	140.00			822	225.00
815	150.00			825	250.00
816	160.00				

8 TERMINAL ⁵
3 1/4-20 threaded Stud
6 M6 threaded Stud
A Plug-In Stud ³

9 ACTUATOR COLOR ²

LEGEND	ON-OFF	Dual	Legend Color
White	B	1	Black
Black	D	2	White
Red	G	3	White
Green	J	4	White
Blue	L	5	White
Yellow	N	6	Black
Gray	Q	7	Black
Orange	S	8	Black

10 MOUNTING
Threaded Insert
1 6-32 x 0.195 inches
2 ISO M3 x 5mm

11 MAXIMUM APPLICATION RATING
M 80 DC

12 AGENCY APPROVAL ⁶
A Without Approval
G UL489 Listed
J UL489A Listed, TUV Certified
K UL489A Listed, VDE Certified
T UL489A Listed
7 UL489A Listed, TUV Certified

Notes:

- Handle moves to Mid-Position only upon electrical trip of C/B when Actuator S is specified. When Actuator Code T is specified, handle moves to Mid Position and Alarm Switch actuates only upon electrical trip of C/B. Code T is only available with Circuit Code N.
- Standard Handle colors are White, Black, Red & Yellow.
- Breakers with Terminal Codes 3 & 6 are supplied with bus bars connecting the Line and Load Terminals. For Terminal Code A, Line and Load Terminals must be connected to a copper bus bar having a minimum cross-section of 0.078 square inches. Terminal Code A is not available on the single pole unit.
Ratings for 101 to 125 amps are available in 1-pole.
Ratings from 110 to 200 amps are available in 2-pole.
For ratings from 225-300 amps, specify 3-pole.
- 1 pole only available with terminal codes 3 and 6.
- Agency codes K and 7 are not available with 1 pole.
Agency code J is only available with 1 pole.
Agency code G is only available in 2 and 3 pole.
- Circuit P, ratings 101-150 amps (2 pole) and ratings 151-250 amps (3 pole).

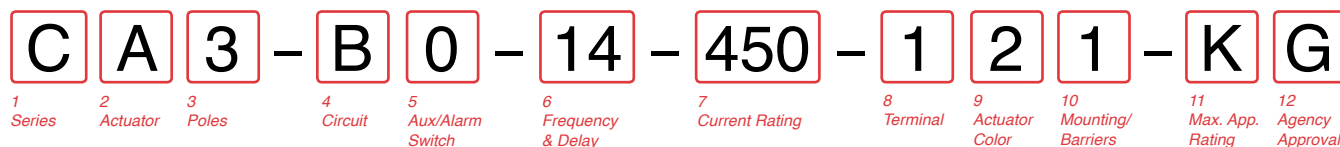

1 SERIES
C

2 ACTUATOR 1
A Handle, one per pole
B Handle, one per multipole unit
S Mid-Trip Handle, one per pole
T Mid-Trip Handle, one per pole & Alarm Switch

3 POLES 2
1 One 2 Two 3 Three

4 CIRCUIT
B Series Trip (Current)

5 AUXILIARY / ALARM SWITCH 3

0	without Aux Switch	6	S.P.S.T., 0.139 Solder Lug
2	S.P.D.T., 0.110 Q.C. Term.	8	S.P.S.T., 0.187 Q.C. Term.
3	S.P.D.T., 0.139 Solder Lug	9	S.P.D.T., 0.187 Q.C. Term.
4	S.P.D.T., 0.110 Q.C. Term. (Gold Contacts)		

6 FREQUENCY & DELAY

11	DC Ultra Short	26	50/60Hz Long
12	DC Short	42 ⁴	50/60Hz Short, Hi-Inrush
14	DC Medium	44 ⁴	50/60Hz Medium, Hi-Inrush
16	DC Long	46 ⁴	50/60Hz Long, Hi-Inrush
21	50/60Hz Ultra Short	52 ⁴	DC Short, Hi-Inrush
22	50/60Hz Short	54 ⁴	DC Medium, Hi-Inrush
24	50/60Hz Medium	56 ⁴	DC Long, Hi-Inrush

7 CURRENT RATING (AMPERES)

CODE	AMPERES	CODE	AMPERES	CODE	AMPERES	CODE	AMPERES
210	0.100	295	0.950	470	7.000	618	18.000
215	0.150	410	1.000	475	7.500	620	20.000
220	0.200	512	1.250	480	8.000	622	22.000
225	0.250	415	1.500	485	8.500	624	24.000
230	0.300	517	1.750	490	9.000	625	25.000
235	0.350	420	2.000	495	9.500	630	30.000
240	0.400	522	2.250	610	10.000	635	35.000
245	0.450	425	2.500	710	10.500	640	40.000
250	0.500	527	2.750	611	11.000	660	60.000
255	0.550	430	3.000	711	11.500	670	70.000
260	0.600	435	3.500	612	12.000	680	80.000
265	0.650	440	4.000	712	12.500	685	85.000
270	0.700	445	4.500	613	13.000	690	90.000
275	0.750	450	5.000	614	14.000	695	95.000
280	0.800	455	5.500	615	15.000	810	100.00
285	0.850	460	6.000	616	16.000		
290	0.900	465	6.500	617	17.000		

8 TERMINAL 6

1 ⁷	Stud 10-32	6 ⁹	Stud M6
2 ⁸	Screw 10-32	9 ⁹	7/16" Clip Terminal
3 ⁹	Stud 1/4-20	A ¹⁰	Plug-In Stud
4 ⁸	Stud M5 x 0.8	C ⁸	5/16" Clip Terminal
5 ⁸	Screw M5 x 0.8		

9 ACTUATOR COLOR & LEGEND 11

Actuator Color	ON-OFF	Dual	Legend Color
White	B	1	Black
Black	D	2	White
Red	G	3	White
Green	J	4	White
Blue	L	5	White
Yellow	N	6	Black
Gray	Q	7	Black
Orange	S	8	Black

10 MOUNTING / BARRIERS

	MOUNTING STYLE	BARRIERS 12
	<i>Threaded Insert</i>	
1	6-32 x 0.195 inches	yes
2	ISO M3 x 5mm	yes

11 MAXIMUM APPLICATION RATING

A	65 DC
B	125 DC
C	120/240 AC ²
D	240 AC
K	120 AC
F	277 AC
M	80 DC

12 AGENCY APPROVAL 11

A	without approvals
F	UL489 Listed, CSA Certified & VDE Certified
G	UL489 Listed & CSA Certified
J	UL489 Listed, CSA Certified & TUV Certified

Notes:

- 1 Actuator Code:
A: Handle tie pin spacer(s) and retainers provided assembled with multi-pole units.
B: Handle located, as viewed from front of breaker in left pole. 2 pole maximum.
S: Handle moves to mid-position only upon electrical trip of the breaker.
T: Handle moves to mid-position and alarm switch activates only upon electrical trip of the breaker.
- 2 Standard multipole units have all poles identical except when specifying auxiliary switch and/or mixed poles.
2 & 3 pole circuit breakers required for 120/240 VAC (Maximum application rating code C) applications, have all poles identical except when specifying auxiliary / alarm switch which is normally supplied in extreme right pole per figure B. Terminal barriers are required on all multipole breakers.
Third pole is for 120/240 VAC applications requiring neutral disconnect. The 3rd pole has the same construction as poles 1 & 2.
- 3 On multi-pole breakers, one auxiliary switch is supplied, mounted in the extreme right pole.
VDE approval on auxiliary switch codes 2, 3 & 4 only.
Auxiliary / Alarm Switch with Independent Circuit ie: separate from breaker circuit, only available with circuit breakers rated 50 amp maximum at 80 VDC, 125 VDC, and 120 VAC. Auxiliary / Alarm Switch with Dependent Circuit ie: same as circuit breaker, is supplied from factory with common terminal of auxiliary / alarm switch connected to line terminal on 120/240 and 240 VAC ratings. Circuit breakers rated 120 VAC 50 amp maximum can be supplied with Auxiliary/Alarm switch common terminal connected to breaker line terminal. Consult factory for special catalog number.
- 4 Available up to 50 amps maximum.
- 5 Current ratings 71 - 100 with VDE approvals are available up to two poles maximum.
- 6 Terminal Codes 9 & C are not VDE approved.
- 7 Terminal Code 1 available to 60 amps maximum.
- 8 Terminal Codes 2, 4, 5 & C available to 50 amps maximum.
- 9 Terminal Codes 3, 6 & 9 available to 100 amps maximum.
- 10 Terminal Code A available to 100 amps maximum.
- 11 VDE and TUV approvals require Dual (I-O, ON-OFF) markings on all handles.
- 12 Barriers supplied on multi-pole units only.



1 SERIES
C

2 ACTUATOR 1

Two Color Visi-Rocker

- C Indicate ON, vertical legend
- D Indicate ON, horizontal legend
- E Indicate ON, no legend
- F Indicate OFF, vertical legend
- G Indicate OFF, horizontal legend
- H Indicate OFF, no legend

Push-To-Reset, Visi-Rocker

- N Indicate OFF, vertical legend
- O Indicate OFF, horizontal legend
- P Indicate OFF, no legend

Single color

- J Vertical legend
- K Horizontal legend
- L No legend

Push-To-Reset, Single color

- R Vertical legend
- U Horizontal legend
- V No legend

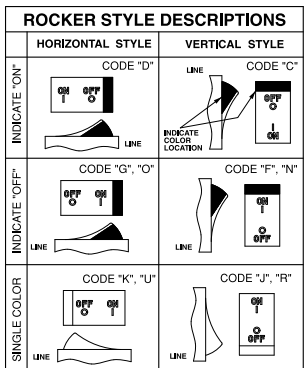

3 POLES 2

- 1 One
- 2 Two
- 3 Three

4 CIRCUIT

- A³ Switch Only (No Coil)
- B Series Trip (Current)
- C Series Trip (Voltage)
- D⁴ Shunt Trip (Current)
- E⁴ Shunt Trip (Voltage)
- F⁴ Relay Trip (Current)
- G⁴ Relay Trip (Voltage)
- H^{4,5} Dual Coil with Shunt Trip Voltage Coil
- K^{4,5} Dual Coil with Relay Trip Voltage Coil

5 AUXILIARY / ALARM SWITCH 6

- 0 without Aux Switch
- 2 S.P.D.T., 0.110 Q.C. Term.
- 3 S.P.D.T., 0.139 Solder Lug
- 4 S.P.D.T., 0.110 Q.C. Term. (Gold Contacts)
- 6 S.P.S.T., 0.139 Solder Lug
- 8 S.P.S.T., 0.187 Q.C. Term.
- 9 S.P.D.T., 0.187 Q.C. Term.

6 FREQUENCY & DELAY

- 03 DC 50/60Hz, Switch Only
- 10⁷ DC Instantaneous
- 11 DC Ultra Short
- 12 DC Short
- 14 DC Medium
- 16 DC Long
- 20⁷ 50/60Hz Instantaneous
- 21 50/60Hz Ultra Short
- 22 50/60Hz Short
- 24 50/60Hz Medium
- 26 50/60Hz Long
- 30 DC 50/60Hz Instantaneous
- 31 DC 50/60Hz Ultra Short
- 32 DC 50/60Hz Short
- 34 DC 50/60Hz Medium
- 36 DC 50/60Hz Long
- 42⁸ 50/60Hz Short, Hi-Inrush
- 44⁸ 50/60Hz Medium, Hi-Inrush
- 46⁸ 50/60Hz Long, Hi-Inrush
- 52⁸ DC Short, Hi-Inrush
- 54⁸ DC Medium, Hi-Inrush
- 56⁸ DC Long, Hi-Inrush

Notes:

- 1 Push-To-Reset actuators have OFF portion of rocker shrouded.
- 2 Multi-pole breakers have all poles identical except when specifying Auxiliary switch and/or mixed poles, and have one rocker per breaker. Rocker location as viewed from front panel: 2 pole – left pole; 3 pole – center pole.
- 3 Switch Only circuits, rated up to 50 amps and 3 poles, and only available with VDE Certification when tied to a protected pole (Circuit Code B, C, D or H.). For .02 to 30 amps, select Current Code 630. For 35 - 50 amps, select Current Code 650. For 55-70 amps, select Current Code 670. For 75-100 amps, select Current Code 810.
- 4 Circuit Codes D,E,F,G,H & K available with Terminal Codes 1,2,4 & 5 only. Circuit Codes D,F,H & K available up to 50 amps maximum Current Rating.
- 5 Consult factory for available Dual Coil options, as special catalog number is required. Dual Coil Voltage Coils with Shunt Trip Construction trip instantaneously on line voltage. Dual Coil Voltage Coils require 30VA minimum power to trip instantaneously and are rated for intermittent duty only.
- 6 Auxiliary Switch available with Series Trip and Switch Only circuits. On multi-pole breakers, one auxiliary switch is supplied, mounted in the extreme right pole. Auxiliary switch codes 2, 3 & 4 are VDE approved.
- 7 Voltage coils not rated for continuous duty. Available only with delay codes 10 & 20.
- 8 Available with Circuit Codes B & D only, and up to 50 amps maximum.
- 9 Current Ratings 60-70 are available up to four poles maximum. Ratings 71-100 are available up to two poles maximum.
- 10 Terminal Code 1 available to 60 amps maximum.
- 11 Terminal Codes 2,4,5 & C available to 50 amps maximum.
- 12 Terminal Codes 3,6 & 9 available to 100 amps maximum.
- 13 Terminal Code 7 available to 25 amps maximum.
- 14 Terminal Code A available to 100 amps maximum.
- 15 Terminal Codes 7, 9 & C are not VDE approved.
- 16 Color shown is visi and legend with remainder of rocker black
- 17 Legend on Push-to-reset bezel/shroud is white when single color rocker is ordered. Dual = ON-OFF/I-O legend with actuator codes C - G, and J, K, N, O, R, & U. None = no legend with actuator codes H, L, P, V. Rockerguard available with actuator codes C - L. Push-to-reset available with actuator codes N, O, P, R, U, V.
- 18 VDE/TUV approval requires Dual (I-O, ON-OFF) or I-O markings on rocker.
- 19 VDE/TUV: 30 amps max.; UL/CSA: 50 amps max.; Available in 2 - 4 poles only and limited to AC Delays. "General Purpose amps" not rated for "full load amps" or to be used in applications with a motor.

7 CURRENT RATING (AMPERES)

CODE	AMPERES				
020	0.020	235	0.350	430	3.000
025	0.025	240	0.400	435	3.500
030	0.030	245	0.450	440	4.000
035	0.035	250	0.500	445	4.500
040	0.040	255	0.550	450	5.000
045	0.045	260	0.600	455	5.500
050	0.050	265	0.650	460	6.000
055	0.055	270	0.700	465	6.500
060	0.060	275	0.750	470	7.000
065	0.065	280	0.800	475	7.500
070	0.070	285	0.850	480	8.000
075	0.075	290	0.900	485	8.500
080	0.080	295	0.950	490	9.000
085	0.085	410	1.000	495	9.500
090	0.090	512	1.250	610	10.000
095	0.095	415	1.500	710	10.500
210	0.100	517	1.750	611	11.000
215	0.150	420	2.000	711	11.500
220	0.200	522	2.250	612	12.000
225	0.250	425	2.500	712	12.500
230	0.300	527	2.750	613	13.000

OR VOLTAGE COIL (NORMAL RATED VOLTAGE) 7

CODE	AMPERES				
A06	6 DC	A32	32 DC	J12	12 AC
A12	12 DC	A48	48 DC	J18	18 AC
A18	18 DC	A65	65 DC	J24	24 AC
A24	24 DC	J06	6 AC	J48	48 AC
				J65	65 AC
				K20	120 AC
				L40	240 AC

8 TERMINAL

- 1¹⁰ Stud 10-32
- 2¹¹ Screw 10-32
- 3¹² Stud 1/4-20
- 4¹¹ Stud M5 x 0.8
- 5¹¹ Screw M5 x 0.8
- 6¹² Stud M6
- 7¹³ 0.250 Double Quick Connect
- 9 7/16" Clip Terminal
- A¹⁴ Plug-In Stud
- C 5/16" Clip Terminal

9 ACTUATOR COLOR & LEGEND 16,17,18

Actuator or Visi-Color	Marking:	Marking Color:	Single Color	Rocker/Handle	Visi-Rocker
Color:	I-O	ON-OFF	Dual/None		
White	A	B	1	Black	White
Black	C	D	2	White	n/a
Red	F	G	3	White	Red
Green	H	J	4	White	Green
Blue	K	L	5	White	Blue
Yellow	M	N	6	Black	Yellow
Gray	P	Q	7	Black	Gray
Orange	R	S	8	Black	Orange

10 MOUNTING / BARRIERS 1

	STANDARD ROCKER BEZEL	BARRIERS	VOLTAGE
1	6-32 x 0.195 inches	no	<300
2	6-32 x 0.195 inches	yes	<300
3 ¹⁹	6-32 x 0.195 inches	yes	≥300
4	ISO M3 x 5mm	no	<300
5	ISO M3 x 5mm	yes	<300
6 ¹⁹	ISO M3 x 5mm	yes	≥300
	ROCKERGUARD BEZEL		
A	6-32 x 0.195 inches	no	<300
C	6-32 x 0.195 inches	yes	<300
E ¹⁹	6-32 x 0.195 inches	yes	≥300
G	ISO M3 x 5mm	no	<300
J	ISO M3 x 5mm	yes	<300
L ¹⁹	ISO M3 x 5mm	yes	≥300
	PUSH-TO-RESET BEZEL		
B	6-32 x 0.195 inches	no	<300
D	6-32 x 0.195 inches	yes	<300
F ¹⁹	6-32 x 0.195 inches	yes	≥300
H	ISO M3 x 5mm	no	<300
J	ISO M3 x 5mm	yes	<300
M ¹⁹	ISO M3 x 5mm	yes	≥300

11 AGENCY APPROVAL

- C UL Recognized & CSA Accepted
- D VDE Certified, UL Recognized & CSA Accepted
- E TUV Certified, UL Recognized & CSA Accepted
- H UL489 Construction: VDE Certified, UL Recognized & CSA Accepted
- I UL Recognized STD 1077, UL Recognized 1500 (ignition protected), & CSA Accepted
- L UL489 Construction: UL Recognized & CSA Accepted
- R UL489 Construction: TUV Certified, UL Recognized & CSA Accepted

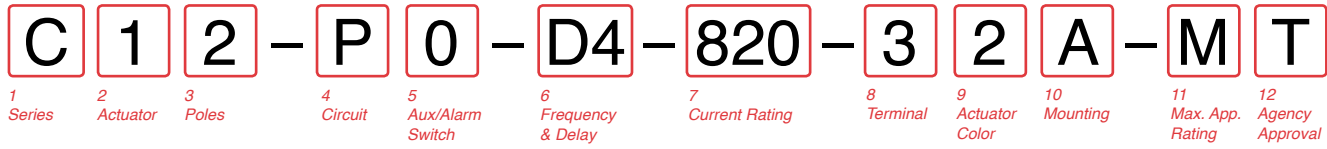

1 SERIES
C

2 ACTUATOR

C Curved Rocker, Two Color Visi, Indicate On, Vertical Legend
D Curved Rocker, Two Color Visi, Indicate On, Horizontal Legend
F Curved Rocker, Two Color Visi, Indicate Off, Vertical Legend
G Curved Rocker, Two Color Visi, Indicate Off, Horizontal Legend
J Curved Rocker, Single Color, Vertical Legend
K Curved Rocker, Single Color, Horizontal Legend
N Curved Rocker, Push To Reset, Two Color Visi, Vertical Legend
O Curved Rocker, Push To Reset, Two Color Visi, Horizontal Legend
1 Flat Rocker, Two Color Visi, Vertical Legend
2 Flat Rocker, Two Color Visi, Horizontal Legend
3 Flat Rocker, Single Color, Vertical Legend
4 Flat Rocker, Single Color, Horizontal Legend
5 Flat Rocker, Push To Reset, Two Color Visi, Vertical Legend
6 Flat Rocker, Push To Reset, Two Color Visi, Horizontal Legend
7 Flat Rocker, Push To Reset, Single Color, Vertical Legend
8 Flat Rocker, Push To Reset, Single Color, Horizontal Legend

3 POLES²

1 One	2 Two	3 Three
--------------	--------------	----------------

4 CIRCUIT
P Series Trip (parallel pole)

5 AUXILIARY/ALARM SWITCH

0 without Aux Switch	6 S.P.S.T., 0.139 Solder Lug
2 S.P.D.T., 0.110 Q.C. Term.	7 S.P.S.T., 0.110 Q.C.
3 S.P.D.T., 0.139 Solder Lug	Term. (Gold Contacts)
4 S.P.D.T., 0.110 Q.C. Term. (Gold Contacts)	8 S.P.S.T., 0.187 Q.C. Term.
5 S.P.S.T., N.O., 0.110 Q.C. Term. (Gold Contacts)	9 S.P.D.T., 0.187 Q.C. Term.

6 FREQUENCY & DELAY

D1 DC Ultra Short
D2 DC Short
D4 DC Medium
D6 DC Long

7 CURRENT RATING (AMPERES)²

CODE	AMPERES						
810	100.00	813	130.00	817	170.00	820	200.00
811	110.00	814	140.00	917	175.00	922	225.00
812	120.00	815	150.00	818	180.00	825	250.00
912	125.00	816	160.00	819	190.00		

8 TERMINAL³

3 Stud 1/4-20
6 Stud M6
A Plug-In Stud¹

9 ACTUATOR COLOR

LEGEND			
ON-OFF	Dual	Legend	Color
White	B	1	Black
Black	D	2	White
Red	G	3	White
Green	J	4	White
Blue	L	5	White
Yellow	N	6	Black
Gray	Q	7	Black
Orange	S	8	Black

10 MOUNTING
ROCKER / MOUNTING INSERT STYLE

A Standard Rocker Bezel - 6-32 Inserts
B Standard Rocker Bezel - M3 Inserts
C Rocker Guard Bezel - 6-32 Inserts
D Rocker Guard Bezel - M3 Inserts
E Standard Bezel with recessed Off Side Flat Rocker - 6-32 Inserts
F Standard Bezel with recessed Off Side Flat Rocker - M3 Inserts
G Push to Reset Bezel - 6-32 Inserts
H Push to Reset Bezel - M3 Inserts

11 MAXIMUM APPLICATION RATING
M 80 DC

12 AGENCY APPROVAL⁴

A Without Approval
G UL489 Listed
J UL489A Listed, TUV Certified
T UL489A Listed
7 UL489A Listed, TUV Certified

- Notes:
- 1 Breakers with Terminal Codes 3 & 6 are supplied with bus bars connecting the Line and Load Terminals. For Terminal Code A, Line and Load Terminals must be connected to a copper bus bar having a minimum cross-section of 0.078 square inches. Terminal Code A is not available on the single pole unit.
 - 2 Ratings for 101 to 125 amps are available in 1-pole. Ratings from 110 to 200 amps are available in 2-pole. For ratings from 225-300 amps, specify 3-pole.
 - 3 1 pole only available with terminal codes 3 and 6.
 - 4 Agency codes K and 7 are not available with 1 pole. Agency code J is only available with 1 pole. Agency code G is only available in 2 and 3 pole. Circuit P, ratings 101-150 amps (2 pole) and ratings 151-250 amps (3 pole).



1 SERIES
C

2 ACTUATOR 1
Two Color Visi-Rocker **Single color**

C Indicate ON, vertical legend **J** Vertical legend
D Indicate ON, horizontal legend **K** Horizontal legend
F Indicate OFF, vertical legend
G Indicate OFF, horizontal legend

ROCKER STYLE DESCRIPTIONS

VERTICAL STYLE	INDICATE "ON" CODE "C" 	INDICATE "OFF" CODE "F" 	SINGLE COLOR CODE "J"
	INDICATE COLOR LOCATION 		
HORIZONTAL STYLE	CODE "D" 	CODE "G" 	CODE "K"

3 POLES 1
1 One 2 Two 3 Three

4 CIRCUIT
B Series Trip (current)

5 AUXILIARY / ALARM SWITCH 2

0 without Aux Switch	6 S.P.D.T., 0.139 Solder Lug
2 S.P.D.T., 0.110 Q.C. Term.	8 S.P.S.T., 0.187 Q.C. Term.
3 S.P.D.T., 0.139 Solder Lug	9 S.P.D.T., 0.187 Q.C. Term.
4 S.P.D.T., 0.110 Q.C. Term. (Gold Contacts)	

6 FREQUENCY & DELAY

11 DC Ultra Short	42 ⁸ 50/60Hz Short, Hi-Inrush
12 DC Short	44 ⁸ 50/60Hz Medium, Hi-Inrush
14 DC Medium	46 ⁸ 50/60Hz Long, Hi-Inrush
16 DC Long	52 ⁸ DC Short, Hi-Inrush
21 50/60Hz Ultra Short	54 ⁸ DC Medium, Hi-Inrush
22 50/60Hz Short	56 DC Long, Hi-Inrush
24 50/60Hz Medium	
26 50/60Hz Long	

- Notes:
- Multi-pole breakers have all breakers identical except when specifying Auxiliary switch and/or mixed poles, and have one rocker per breaker.
 - On multi-pole breakers, one auxiliary switch is supplied, mounted in the extreme right pole.
 - Available up to 50 amps maximum.
 - Current ratings 71 - 100 with VDE approvals are available up to two poles maximum.
 - Terminal Code 1 available to 60 amps maximum.
 - Terminal Codes 2, 4, 5 & C available to 50 amps maximum.
 - Terminal Codes 3, 6, 9 & A available to 100 amps maximum.
 - Terminal Codes 9 & C are not VDE approved.
 - Color shown is visi and legend with remainder of rocker black
 - Dual = ON-OFF/I-O legend on actuator.
 - VDE and TUV approval requires Dual (I-O, ON-OFF) markings on rocker.
 - Rockerguard available with all actuator codes.
 - Barriers supplied on multi-pole units only.
 - 2 & 3 pole circuit breakers required for 120/240 AC rating.

7 CURRENT RATING (AMPERES) 4

CODE	AMPERES	CODE	AMPERES	CODE	AMPERES	CODE	AMPERES
210	0.100	295	0.950	470	7.000	618	18.000
215	0.150	410	1.000	475	7.500	620	20.000
220	0.200	512	1.250	480	8.000	622	22.000
225	0.250	415	1.500	485	8.500	624	24.000
230	0.300	517	1.750	490	9.000	625	25.000
235	0.350	420	2.000	495	9.500	630	30.000
240	0.400	522	2.250	610	10.000	635	35.000
245	0.450	425	2.500	710	10.500	640	40.000
250	0.500	527	2.750	611	11.000	650	50.000
255	0.550	430	3.000	711	11.500	660	60.000
260	0.600	435	3.500	612	12.000	670	70.000
265	0.650	440	4.000	712	12.500	680	80.000
270	0.700	445	4.500	613	13.000	685	85.000
275	0.750	450	5.000	614	14.000	690	90.000
280	0.800	455	5.500	615	15.000	695	95.000
285	0.850	460	6.000	616	16.000	810	100.00
290	0.900	465	6.500	617	17.000		

8 TERMINAL

1 ⁵ Stud 10-32	6 ⁷ Stud M6
2 ⁶ Screw 10-32 with saddle & washer clamps	9 ^{7,8} 7/16" Clip Terminal
3 ⁷ Stud 1/4-20	A ^{7,8} Plug-In Stud
4 ⁶ Stud M5 x 0.8	C ^{6,8} 5/16" Clip Terminal
5 ⁶ Screw M5 x 0.8 with saddle & washer clamps	

9 ACTUATOR COLOR & LEGEND 11

Actuator or Visi-Color	Marking:	Marking Color:	Single Color	Rocker/Handle	Visi-Rocker
White	B	1	Black	Black	White
Black	D	2	White	White	n/a
Red	G	3	White	White	Red
Green	J	4	White	White	Green
Blue	L	5	White	White	Blue
Yellow	N	6	Black	Black	Yellow
Gray	Q	7	Black	Black	Gray
Orange	S	8	Black	Black	Orange

10 MOUNTING / BARRIERS 12

	Standard Rocker Bezel Threaded Insert, 2 per pole	BARRIERS 13
A	6-32 X 0.195 inches	yes
C	ISO M3 x 5mm	yes
	Rockerguard Bezel Threaded Insert, 2 per pole	
B	6-32 x 0.195 inches	yes
D	ISO M3 x 5mm	yes

11 MAXIMUM APPLICATION RATING

A	65 DC
B	125 DC
C	120/240 AC 14
D	240 AC
F	277 AC
K	120 AC
M	80 DC

12 AGENCY APPROVAL

A	without approvals
F	UL 489 Listed, CSA Certified, & VDE Certified
G	UL 489 Listed & CSA Certified
J	UL489 Listed, CSA Certified & TUV Certified

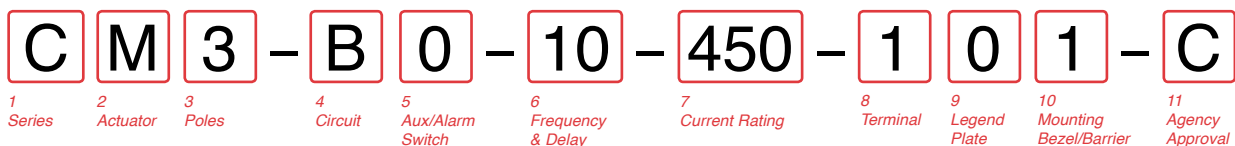

1 SERIES

C

2 ACTUATOR ¹

M Sealed Toggle, one per pole

3 POLES

1 One **2** Two **3** Three

4 CIRCUIT

A ² Switch Only (no coil)	F ³ Relay Trip (current)
B Series Trip (current)	G ³ Relay Trip (voltage)
C Series Trip (voltage)	H ^{3,4} Dual Coil with Shunt Trip Voltage Coil
D ³ Shunt Trip (current)	K ^{3,4} Dual Coil with Relay Trip Voltage Coil
E ³ Shunt Trip (voltage)	

5 AUXILIARY / ALARM SWITCH

0 without Aux Switch	6 S.P.S.T., 0.110 Q.C. Term.
2 S.P.D.T., 0.110 Q.C. Term.	8 S.P.S.T., 0.187 Q.C. Term.
3 S.P.D.T., 0.139 Solder Lug	9 S.P.D.T., 0.187 Q.C. Term.
4 S.P.D.T., 0.110 Q.C. Term. (Gold Contacts)	

6 FREQUENCY & DELAY

03 ² DC 50/60Hz, Switch Only	30 DC 50/60Hz Instantaneous
10 ⁶ DC Instantaneous	31 DC 50/60Hz Ultra Short
11 DC Ultra Short	32 DC 50/60Hz Short
12 DC Short	34 DC 50/60Hz Medium
14 DC Medium	36 DC 50/60Hz Long
16 DC Long	42 ⁷ 50/60Hz Short, Hi-Inrush
20 ⁶ 50/60Hz Instantaneous	44 ⁷ 50/60Hz Medium, Hi-Inrush
21 50/60Hz Ultra Short	46 ⁷ 50/60Hz Long, Hi-Inrush
22 50/60Hz Short	52 ⁷ DC Short, Hi-Inrush
24 50/60Hz Medium	54 ⁷ DC Medium, Hi-Inrush
26 50/60Hz Long	56 DC Long, Hi-Inrush

7 CURRENT RATING (AMPERES) ⁹

CODE	AMPERES	CODE	AMPERES	CODE	AMPERES	CODE	AMPERES
020	0.020	235	0.350	430	3.000	614	14.000
025	0.025	240	0.400	435	3.500	615	15.000
030	0.030	245	0.450	440	4.000	616	16.000
035	0.035	250	0.500	445	4.500	617	17.000
040	0.040	255	0.550	450	5.000	618	18.000
045	0.045	260	0.600	455	5.500	620	20.000
050	0.050	265	0.650	460	6.000	622	22.000
055	0.055	270	0.700	465	6.500	624	24.000
060	0.060	275	0.750	470	7.000	625	25.000
065	0.065	280	0.800	475	7.500	630	30.000
070	0.070	285	0.850	480	8.000	635	35.000
075	0.075	290	0.900	485	8.500	640	40.000
080	0.080	295	0.950	490	9.000	650	50.000
085	0.085	410	1.000	495	9.500	660 ⁹	60.000
090	0.090	512	1.250	610	10.000	670 ⁹	70.000
095	0.095	415	1.500	710	10.500	680 ⁹	80.000
210	0.100	517	1.750	611	11.000	685 ⁹	85.000
215	0.150	420	2.000	711	11.500	690 ⁹	90.000
220	0.200	522	2.250	612	12.000	695 ⁹	95.000
225	0.250	425	2.500	712	12.500	810 ⁹	100.00
230	0.300	527	2.750	613	13.000		

OR VOLTAGE COIL (NORMAL RATED VOLTAGE) ⁷

CODE	AMPERES	CODE	VOLTS	CODE	VOLTS	CODE	VOLTS
A06	6 DC	A32	32 DC	J12	12 AC	J65	65 AC
A12	12 DC	A48	48 DC	J18	18 AC	K20	120 AC
A18	18 DC	A65	65 DC	J24	24 AC	L40	240 AC
A24	24 DC	J06	6 AC	J48	48 AC		

8 TERMINAL

1 ⁹ Stud 10-32	6 ¹¹ Stud M6
2 ¹⁰ Screw 10-32	7 ¹² 0.250 Double Click Connect
3 ¹¹ Stud 1/4-20	9 ¹¹ 7/16" Clip Terminal
4 ¹⁰ Stud M5 x 0.8	A ¹³ Plug-In Stud
5 ¹⁰ Screw M5 x 0.8	C ¹⁰ 5/16" Clip Terminal

9 LEGEND PLATE

0 No Legend

10 MOUNTING / BARRIERS

MOUNTING STYLE	BARRIERS
1 Standard Hex Nut	no
A Standard Hex Nut (multi-pole units only)	yes

11 AGENCY APPROVAL

C	UL Recognized & CSA Accepted
I	UL Recognized & CSA Accepted, UL1500 ignition protection
L	UL Recognized & CSA Accepted with listed construction

Notes:

- 1 Actuator Code M: Handle location as viewed from front of breaker:
2 pole - right pole 3 pole - center pole
- 2 Switch Only circuits, rated up to 50 amps and 3 poles, and only available with VDE. For .02 to 30 amps, select Current Code 630. For 35 - 50 amps, select Current Code 650. For 55-70 amps, select Current Code 670. For 75-100 amps, select Current Code 810.
- 3 Circuit Codes D,E,F,G,H & K available with Terminal Codes 1,2,4 & 5 only.
- 4 Consult factory for available Dual Coil options, as special catalog number is required. Dual Coil Voltage Coils with Shunt Trip Construction trip instantaneously on line voltage. Dual Coil Voltage Coils require 30VA minimum power to trip instantaneously and are rated for intermittent duty only.
- 5 Auxiliary Switch available with Series Trip and Switch Only circuits. On multi-pole breakers, one auxiliary switch is supplied, mounted in the extreme right pole.
- 6 Voltage coils not rated for continuous duty. Available only with delay codes 10 & 20.
- 7 Available with Circuit Codes B & D only, and up to 50 amps maximum.
- 8 Consult factory for current ratings 71-100, in three pole units, available as special catalog number only.
- 9 Terminal Code 1 available to 60 amps maximum.
- 10 Terminal Codes 2, 4, 5 and C available to 50 amps maximum.
- 11 Terminal Codes 3, 6 & 9 available to 100 amps maximum.
- 12 Terminal Code 7 available to 25 amps maximum.
- 13 Terminal Code A available to 100 amps maximum.

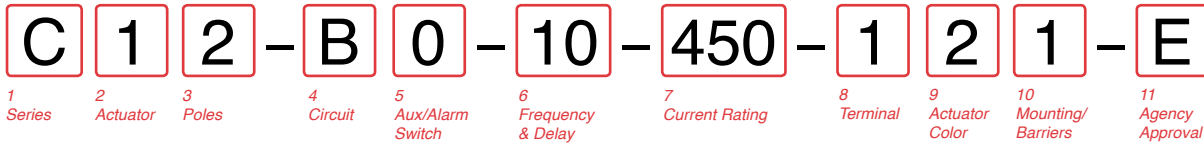

1 SERIES
C

2 ACTUATOR 1
Two Color Visi-Rocker

- 1 Indicate OFF, vertical legend
- 2 Indicate OFF, horizontal legend

Single color

- 3 Vertical legend
- 4 Horizontal legend

Push-To-Reset, Visi-Rocker

- 5 Indicate OFF, vertical legend
- 6 Indicate OFF, horizontal legend

Push-To-Reset, Single color

- 7 Vertical legend
- 8 Horizontal legend

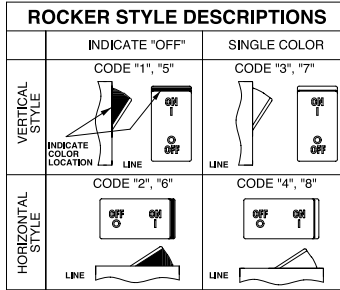

3 POLES 2

1 One	2 Two	3 Three
-------	-------	---------

4 CIRCUIT

A ³ Switch Only (No Coil)	F ⁴ Relay Trip (Current)
B Series Trip (Current)	G ⁴ Relay Trip (Voltage)
C Series Trip (Voltage)	H ^{4,5} Dual Coil with Shunt Trip Voltage Coil
D ⁴ Shunt Trip (Current)	K ^{4,5} Dual Coil with Relay Trip Voltage Coil
E ⁴ Shunt Trip (Voltage)	

5 AUXILIARY / ALARM SWITCH 6

0 without Aux Switch	6 S.P.D.T., 0.139 Solder Lug
2 S.P.D.T., 0.110 Q.C. Term.	8 S.P.S.T., 0.187 Q.C. Term.
3 S.P.D.T., 0.139 Solder Lug	9 S.P.D.T., 0.187 Q.C. Term.
4 S.P.D.T., 0.110 Q.C. Term. (Gold Contacts)	

6 FREQUENCY & DELAY

03 DC 50/60Hz, Switch Only	30 DC 50/60Hz Instantaneous
10 7 DC Instantaneous	31 DC 50/60Hz Ultra Short
11 DC Ultra Short	32 DC 50/60Hz Short
12 DC Short	34 DC 50/60Hz Medium
14 DC Medium	36 DC 50/60Hz Long
16 DC Long	42 ⁸ 50/60Hz Short, Hi-Inrush
20 7 50/60Hz Instantaneous	44 ⁸ 50/60Hz Medium, Hi-Inrush
21 50/60Hz Ultra Short	46 ⁸ 50/60Hz Long, Hi-Inrush
22 50/60Hz Short	52 ⁸ DC Short, Hi-Inrush
24 50/60Hz Medium	54 ⁸ DC Medium, Hi-Inrush
26 50/60Hz Long	56 ⁸ DC Long, Hi-Inrush

- Notes:
- 1 Push-to-reset actuators have OFF portion of rocker shrouded.
 - 2 Multi-pole breakers have all poles identical except when specifying Auxiliary switch and/or mixed poles, and have one rocker per breaker. Rocker location as viewed from front panel: 2 pole – left pole; 3 pole – center pole.
 - 3 Switch Only circuits, rated up to 50 amps and 3 poles, and only available with VDE Certification when tied to a protected pole (Circuit Code B, C, D or H.). For .02 to 30 amps, select Current Code 630. For 35 - 50 amps, select Current Code 650. For 55-70 amps, select Current Code 670. For 75-100 amps, select Current Code 810.
 - 4 Circuit Codes D,E,F,G,H & K available with Terminal Codes 1,2,4 & 5 only. Circuit Codes D,F,H & K available up to 50 amps maximum Current Rating.
 - 5 Consult factory for available Dual Coil options, as special catalog number is required. Dual Coil Voltage Coils with Shunt Trip Construction trip instantaneously on line voltage. Dual Coil Voltage Coils require 30VA minimum power to trip instantaneously and are rated for intermittent duty only.
 - 6 Auxiliary Switch available with Series Trip and Switch Only circuits. On multi-pole breakers, one auxiliary switch is supplied, mounted in the extreme right pole. Auxiliary switch codes 2, 3 & 4 are VDE approved.
 - 7 Voltage coils not rated for continuous duty. Available only with delay codes 10 and 20.
 - 8 Available with Circuit Codes B & D only, and up to 50 amps maximum.
 - 9 Current ratings 60-70 are available up to four poles maximum. Current ratings 71 - 100 are available up to two poles maximum.
 - 10 Terminal Code 1 available to 60 amps maximum.
 - 11 Terminal Codes 2,4,5 & C available to 50 amps maximum.
 - 12 Terminal Codes 3,6 & 9 available to 100 amps maximum.
 - 13 Terminal Code 7 available to 25 amps maximum.
 - 14 Terminal Code A available to 100 amps maximum.
 - 15 Terminal Codes 7, 9 & C are not VDE approved.
 - 16 Color shown is visi & legend with remainder of rocker black. Dual = ON-OFF/I-O legend.
 - 17 Legend on Push-to-reset bezel/shroud is white with single color actuator codes 7 & 8. Legend on Push-to-reset bezel/shroud matches visi-color of rocker with actuator codes 5 & 6.
 - 18 VDE/TUV approval requires Dual (I-O, ON-OFF) or I-O markings on rocker.
 - 19 VDE/TUV: 30 amps max.; UL/CSA: 50 amps max.; Available in 2 & 3 poles only and limited to AC Delays. "General Purpose amps" not rated for "full load amps" or to be used in applications with a motor.
 - 20 Recessed "OFF SIDE" available with actuator codes 1,2,3&4. Legends on rocker are available in ink stamping only.

7 CURRENT RATING (AMPERES) 9

CODE	AMPERES	CODE	AMPERES	CODE	AMPERES	CODE	AMPERES
020	0.020	235	0.350	430	3.000	614	14.000
025	0.025	240	0.400	435	3.500	615	15.000
030	0.030	245	0.450	440	4.000	616	16.000
035	0.035	250	0.500	445	4.500	617	17.000
040	0.040	255	0.550	450	5.000	618	18.000
045	0.045	260	0.600	455	5.500	620	20.000
050	0.050	265	0.650	460	6.000	622	22.000
055	0.055	270	0.700	465	6.500	624	24.000
060	0.060	275	0.750	470	7.000	625	25.000
065	0.065	280	0.800	475	7.500	630	30.000
070	0.070	285	0.850	480	8.000	635	35.000
075	0.075	290	0.900	485	8.500	640	40.000
080	0.080	295	0.950	490	9.000	650	50.000
085	0.085	410	1.000	495	9.500	660 ⁹	60.000
090	0.090	512	1.250	610	10.000	670 ⁹	70.000
095	0.095	415	1.500	710	10.500	680 ⁹	80.000
210	0.100	517	1.750	611	11.000	685 ⁹	85.000
215	0.150	420	2.000	711	11.500	690 ⁹	90.000
220	0.200	522	2.250	612	12.000	695 ⁹	95.000
225	0.250	425	2.500	712	12.500	810 ⁹	100.000
230	0.300	527	2.750	613	13.000		

OR VOLTAGE COIL (NORMAL RATED VOLTAGE) 7

CODE	AMPERES	CODE	VOLTS	CODE	VOLTS	CODE	VOLTS
A06	6 DC	A32	32 DC	J12	12 AC	J65	65 AC
A12	12 DC	A48	48 DC	J18	18 AC	K20	120 AC
A18	18 DC	A65	65 DC	J24	24 AC	L40	240 AC
A24	24 DC	J06	6 AC	J48	48 AC		

8 TERMINAL

1 ¹⁰ Stud 10-32	6 ¹² Stud M6
2 ¹¹ Screw 10-32	7 ¹³ 0.250 Double Quick Connect
3 ¹² Stud 1/4-20	9 ¹⁵ 7/16" Clip Terminal
4 ¹¹ Stud M5 x 0.8	A ¹⁴ Plug-In Stud
5 ¹¹ Screw M5 x 0.8	C ¹⁵ 5/16" Clip Terminal

9 ACTUATOR COLOR & LEGEND 16,17,18

Actuator or Visi-Color Marking: _____ **Marking Color:** _____

Color:	I-O	ON-OFF	Dual/None	Rocker/Handle	Visi-Rocker
White	A	B	1	Black	White
Black	C	D	2	White	n/a
Red	F	G	3	White	Red
Green	H	J	4	White	Green
Blue	K	L	5	White	Blue
Yellow	M	N	6	Black	Yellow
Gray	P	Q	7	Black	Gray
Orange	R	S	8	Black	Orange

10 MOUNTING / BARRIERS 1

	STANDARD ROCKER BEZEL	BARRIERS	VOLTAGE
1	6-32 x 0.195 inches	no	<300
2	6-32 x 0.195 inches	yes	<300
3 ¹⁹	6-32 x 0.195 inches	yes	≥300
4	ISO M3 x 5mm	no	<300
5	ISO M3 x 5mm	yes	<300
6 ¹⁹	ISO M3 x 5mm	yes	≥300
RECESSED OFF ROCKER			
7	6-32 x 0.195 inches	no	<300
8	6-32 x 0.195 inches	yes	<300
9	6-32 x 0.195 inches	yes	≥300
A	ISO M3 x 5mm	no	<300
C	ISO M3 x 5mm	yes	<300
E	ISO M3 x 5mm	yes	≥300
PUSH-TO-RESET BEZEL			
B	6-32 x 0.195 inches	no	<300
D	6-32 x 0.195 inches	yes	<300
F ¹⁹	6-32 x 0.195 inches	yes	≥300
H	ISO M3 x 5mm	no	<300
J	ISO M3 x 5mm	yes	<300
M ¹⁹	ISO M3 x 5mm	yes	≥300

11 AGENCY APPROVAL

C	UL Recognized & CSA Accepted
E	TUV Certified, UL Recognized & CSA Accepted
I	UL Recognized STD 1077, UL Recognized 1500 (ignition protected), & CSA Accepted
L	UL489 Construction: UL Recognized & CSA Accepted
R	UL489 Construction: TUV Certified, UL Recognized & CSA Accepted

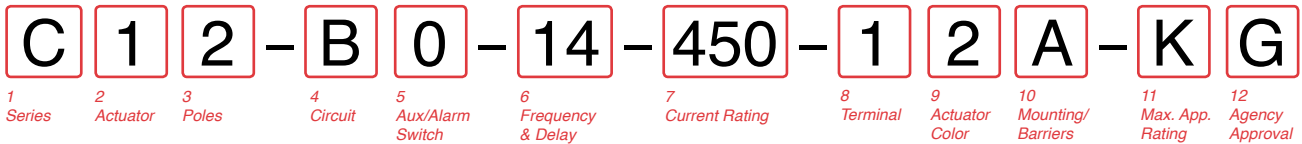

1 SERIES
C

2 ACTUATOR ¹

Two Color Visi-Rocker

- 1 Indicate OFF, vertical legend
- 2 Indicate OFF, horizontal legend
- 3 Vertical legend
- 4 Horizontal legend

Push-To-Reset, Visi-Rocker

- 5 Indicate OFF, vertical legend
- 6 Indicate OFF, horizontal legend
- 7 Vertical legend
- 8 Horizontal legend



3 POLES ²

- 1 One
- 2 Two
- 3 Three

4 CIRCUIT

- B Series Trip (current)

5 AUXILIARY / ALARM SWITCH ³

- 0 without Aux Switch
- 2 S.P.D.T., 0.110 Q.C. Term.
- 3 S.P.D.T., 0.139 Solder Lug
- 4 S.P.D.T., 0.110 Q.C. Term. (Gold Contacts)
- 6 S.P.S.T., 0.139 Solder Lug
- 8 S.P.S.T., 0.187 Q.C. Term.
- 9 S.P.D.T., 0.187 Q.C. Term.

6 FREQUENCY & DELAY

- 11 DC Ultra Short
- 12 DC Short
- 14 DC Medium
- 16 DC Long
- 21 50/60Hz Ultra Short
- 22 50/60Hz Short
- 24 50/60Hz Medium
- 26 50/60Hz Long
- 42 ⁴ 50/60Hz Short, Hi-Inrush
- 44 ⁴ 50/60Hz Medium, Hi-Inrush
- 46 ⁴ 50/60Hz Long, Hi-Inrush
- 52 ⁴ DC Short, Hi-Inrush
- 54 ⁴ DC Medium, Hi-Inrush
- 56 ⁴ DC Long, Hi-Inrush

Notes:

- 1 Push-to-reset actuators have OFF portion of rocker shrouded.
- 2 Multi-pole breakers have all breakers identical except when specifying Auxiliary switch and/or mixed poles, and have one rocker per breaker.
- 3 On multi-pole breakers, one auxiliary switch is supplied, mounted in the extreme right pole.
- 4 Available up to 50 amps maximum.
- 5 Current ratings 71 - 100 with VDE approvals are available up to two poles maximum.
- 6 Terminal Code 1 available to 60 amps maximum.
- 7 Terminal Codes 2, 4, 5 & C available to 50 amps maximum.
- 8 Terminal Codes 3, 6, 9 & A available to 100 amps maximum.
- 9 Terminal Codes 9 & C are not VDE approved.
- 10 Color shown is visi and legend with remainder of rocker black
- 11 Dual = ON-OFF/I-O legend on actuator.
- 12 TUV approval requires Dual (I-O, ON-OFF) markings on rocker.
- 13 Legend on push-to-reset bezel/shroud is white when single color rocker is ordered. Legend on push-to-reset bezel/shroud matches visi-color of rocker with actuator codes 5 & 6.
- 14 Recessed "OFF-SIDE" available with actuator codes 1, 2, 3, & 4. Legends on rocker are available in ink stamping only.
- 15 Barriers supplied on multi-pole units only.
- 16 2 & 3 pole circuit breakers required for 120/240 AC rating.

7 CURRENT RATING (AMPERES) ⁵

CODE	AMPERES	CODE	AMPERES	CODE	AMPERES	CODE	AMPERES
210	0.100	295	0.950	470	7.000	618	18.000
215	0.150	410	1.000	475	7.500	620	20.000
220	0.200	512	1.250	480	8.000	622	22.000
225	0.250	415	1.500	485	8.500	624	24.000
230	0.300	517	1.750	490	9.000	625	25.000
235	0.350	420	2.000	495	9.500	630	30.000
240	0.400	522	2.250	610	10.000	635	35.000
245	0.450	425	2.500	710	10.500	640	40.000
250	0.500	527	2.750	611	11.000	650	50.000
255	0.550	430	3.000	711	11.500	660	60.000
260	0.600	435	3.500	612	12.000	670	70.000
265	0.650	440	4.000	712	12.500	680	80.000
270	0.700	445	4.500	613	13.000	685	85.000
275	0.750	450	5.000	614	14.000	690	90.000
280	0.800	455	5.500	615	15.000	695	95.000
285	0.850	460	6.000	616	16.000	810	100.00
290	0.900	465	6.500	617	17.000		

8 TERMINAL

- 1 ⁶ Stud 10-32
- 2 ⁷ Screw 10-32
- 3 ⁸ Stud 1/4-20
- 4 ⁷ Stud M5 x 0.8
- 5 ⁷ Screw M5 x 0.8
- 6 ⁸ Stud M6
- 9 ^{8,9} 7/16" Clip Terminal
- A ⁸ Plug-In Stud
- C ^{7,9} 5/16" Clip Terminal

9 ACTUATOR COLOR & LEGEND ¹⁰

Actuator or Visi-Color	Marking:	Marking Color:	Single Color	Visi-Rocker
Color:	ON-OFF	Dual ^{11,12}	Rocker/Handle	
White	B	1	Black	White
Black	D	2	White	n/a
Red	G	3	White	Red
Green	J	4	White	Green
Blue	L	5	White	Blue
Yellow	N	6	Black	Yellow
Gray	Q	7	Black	Gray
Orange	S	8	Black	Orange

10 MOUNTING / BARRIERS

	STANDARD ROCKER BEZEL	BARRIERS ¹⁵
	Threaded Insert, 2 per pole	
A	6-32 X 0.195 inches	yes
C	ISO M3 x 5mm	yes
	RECESSED OFF ROCKER ¹⁴	
	Threaded Insert, 2 per pole	
E	6-32 x 0.195 inches	yes
F	ISO M3 x 5mm	yes
	PUSH-TO-RESET BEZEL ¹³	
	Threaded Insert, 2 per pole	
B	6-32 x 0.195 inches	yes
D	ISO M3 x 5mm	yes

11 MAXIMUM APPLICATION RATING

- A 65 DC
- B 125 DC
- C 120/240 AC ¹⁶
- D 240 AC
- F 277 AC
- K 120 AC
- M 80 DC

12 AGENCY APPROVAL ¹²

- A without approvals
- G UL 489 Listed & CSA Certified
- J UL489 Listed, CSA Certified & TUV Certified

Circuit & Terminal Diagrams: in. [mm]

DESCRIPTION	CODE	DIMENSIONAL DETAIL	RATING (AMPS)		
			25	50	100
#10-32 STUD	1				
M5 STUD	4				
#1/4-20 STUD	3				
M6 STUD	6				
#1/4-20 STUD	3				
M6 STUD	6				
#10-32 SCREW	2				
M-5 SCREW	5				

DESCRIPTION	CODE	DIMENSIONAL DETAIL	RATING (AMPS)		
			25	50	100
.250 DOUBLE Q.C.	7				
7/16" CLIP TERMINALS	9				
PUSH-IN STUD	A				

NOTES: TOLERANCE ON STUD LENGTHS IS ±.031 [±.79] UNLESS OTHERWISE SPECIFIED.

AUXILIARY / ALARM SWITCH TERMINAL DETAIL³



TIGHTENING TORQUE SPECIFICATIONS	
THREAD SIZE	TORQUE
#6-32 [M3] MOUNTING INSERTS	7-9 IN-LBS [0.8-1.0 NM]
#10-32 & M5 THD STUDS	15-20 IN-LBS [1.7-2.3 NM]
#10-32 THD SCREW	15-20 IN-LBS [1.7-2.3 NM]
#1/4-20 & M6 THD STUDS	30-35 IN-LBS [3.4-4.0 NM]

TERMINAL HARDWARE				
TERMINAL DESCRIPTION	CODE	AGENCY APPROVAL	AMPERE RATING	HARDWARE SUPPLIED
#10-32 STUD	1	ALL	.02 - 50	LOCK WASHER - FLAT WASHER - NUT
M5 STUD	4	ALL	.02 - 50	LOCK WASHER - FLAT WASHER - NUT
#1/4-20 STUD	3	ALL	.02 - 80	LOCK WASHER - FLAT WASHER - NUT
			81 - 100	LOCK WASHER - NUT - (2) FLAT WASHER - NUT
M6 STUD	6	ALL	.02 - 80	LOCK WASHER - FLAT WASHER - NUT
			81 - 100	LOCK WASHER - NUT - (2) FLAT WASHER - NUT
#10-32 SCREW	2 & 5	UL RECOGNIZED	.02 - 50	* SADDLE CLAMP - FLAT WASHER - SCREW
		UL-489 LISTED	.02 - 50	LOCK WASHER - FLAT WASHER - SCREW
		TUV & VDE CERTIFIED	.02 - 16	* SADDLE CLAMP - FLAT WASHER - SCREW
		TUV & VDE CERTIFIED	16.1 - 50	LOCK WASHER - FLAT WASHER - SCREW

* THE SADDLE CLAMP IS FOR DIRECT WIRE CONNECTION USE. DISCARD SADDLE CLAMP IF WIRE TERMINAL LUG IS USED

Notes:

- All dimensions are in inches [millimeters].
- Tolerance ±.020 [.51] unless otherwise specified.
- Available on Series Trip and Switch Only Circuits when called for on multi-pole units. Only one auxiliary switch is normally supplied, as viewed in multi-pole identification scheme.

Circuit & Terminal Diagrams: in. [mm]

	CIRCUIT SCHEMATIC		CIRCUIT CODE	AUX SWITCH CODE	CIRCUIT SCHEMATIC		CIRCUIT CODE	AUX SWITCH CODE
	ANSI	IEC			ANSI	IEC		
	SWITCH ONLY (NO COIL)				SERIES TRIP			
			A	O			B	O
			A	2 3 4			B	2 3 4
			D E	0			H	0
			F G	0			K	0

HANDLE POSITION VS. AUX/ALARM SWITCH MODE					
CIRCUIT BREAKER MODE	STANDARD C/B		MID TRIP C/B		
	HANDLE POSITION	AUX. SWITCH MODE	HANDLE POSITION	STANDARD ALARM SWITCH MODE	REVERSE ALARM SWITCH MODE ⁴
OFF					
ON					
ELECTRICAL TRIP					

- Notes:
- All dimensions are in inches [millimeters].
 - Tolerance ±.020 [.51] unless otherwise specified.
 - Schematic shown represents current trip circuits.
 - Available only as special catalog number.

Dimensional Specifications: in. [mm]

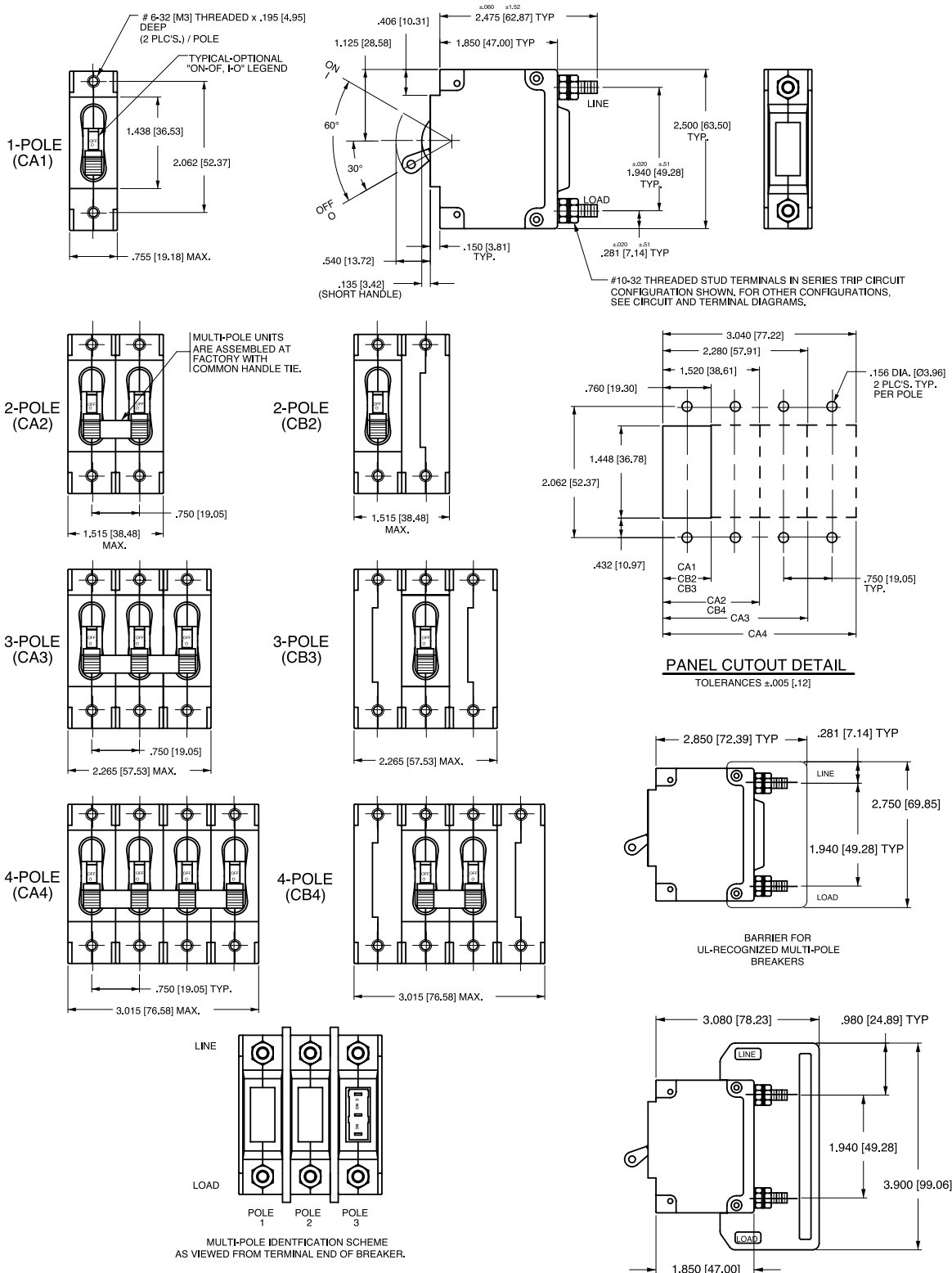

Notes:

- 1 All dimensions are in inches [millimeters].
- 2 Tolerance ±.020 [0.51] unless otherwise specified.

Dimensional Specifications: in. [mm]



*Handleguard available as special catalog number only

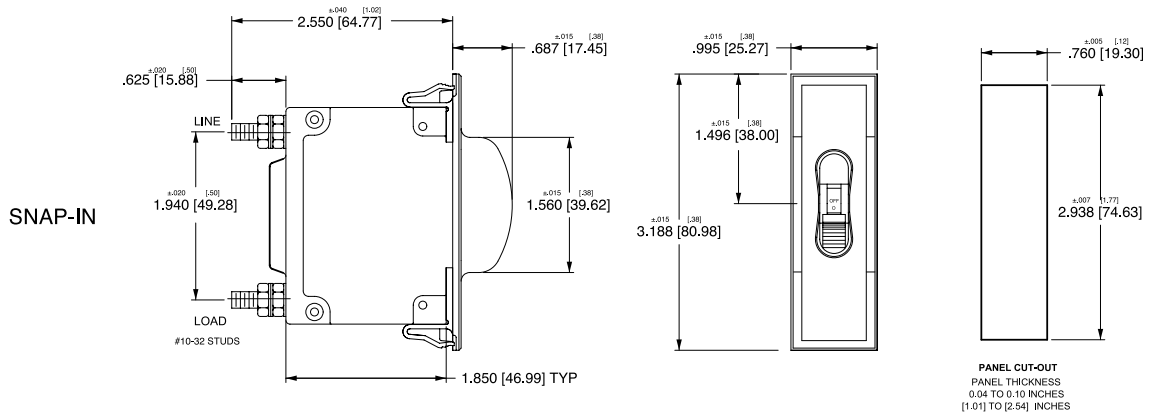

Notes:

- 1 All dimensions are in inches [millimeters].
- 2 Tolerance ± 0.020 [.51] unless otherwise specified.

Dimensional Specifications: in. [mm]

1-POLE (CA1)
w/ ARC CHUTE BARRIER



3-POLE (CA3)
w/ ARC CHUTE BARRIER



INDICATE "ON"

1-POLE (CC1, CD1)
w/ ARC CHUTE (NO BARRIER)

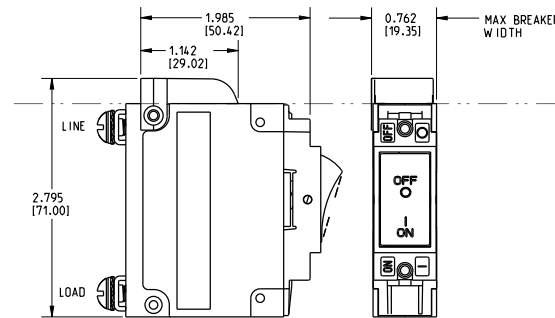

3-POLE (CC3, CD3)
w/ ARC CHUTE BARRIER

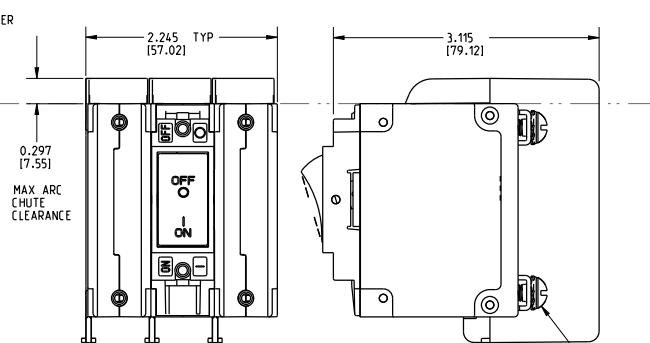

SCREW TYPE TERMINALS IN SERIES TRIP CIRCUIT CONFIGURATION SHOWN.

INDICATE "OFF" / SINGLE COLOR

1-POLE (CF1, CG1, C11, C21)
w/ ARC CHUTE (NO BARRIER)

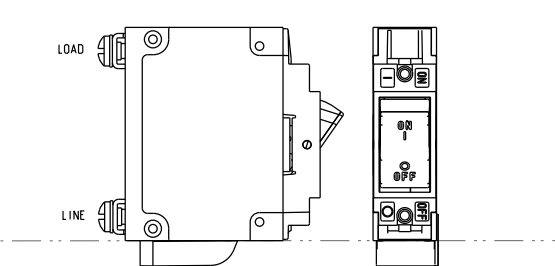

3-POLE (CF3, CG3, C13, C23)
w/ ARC CHUTE BARRIER

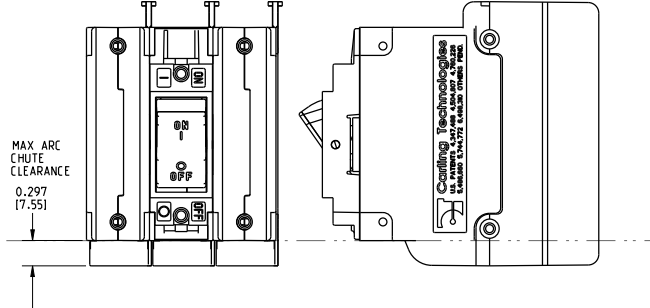

Notes:

- 1 Only 1-pole and 3-pole configurations shown. Arc chute (without barrier) and arc chute barrier also available for 2-pole construction.
- 2 Dimensions apply to all variations shown.
- 3 Notice that line and load terminal orientation for indicate on and indicate off rocker circuit breakers are opposite.
- 4 Screw type terminals shown for Rocker style (CF1, C11, etc) circuit breakers. For other terminal configurations see circuit and terminal diagrams.
- 5 All dimensions are in inches [millimeters].
- 6 Tolerance $\pm .020$ unless otherwise specified.
- 7 Must be ordered under a special catalog number.

Dimensional Specifications: in. [mm]

PARALLEL POLE (CA2-P)



PARALLEL POLE (CA3-P)

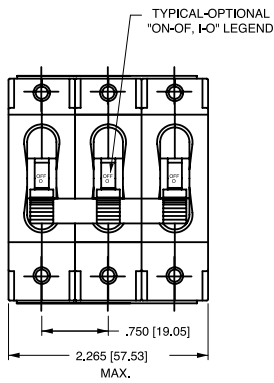

CIRCUIT BREAKER PROFILE	CIRCUIT SCHEMATIC (CA2-P SHOWN)		CIRCUIT CODE	AUX SWITCH CODE
	ANSI	IEC		
	SERIES TRIP 		P	0
	SERIES TRIP WITH AUXILIARY SWITCH 		P	2 3 4

TERMINAL DETAILS

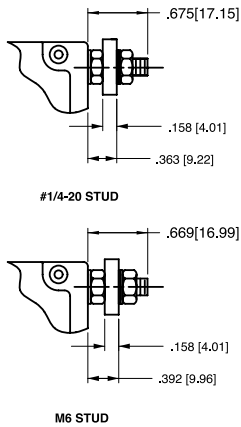

PANEL CUTOUT DETAIL

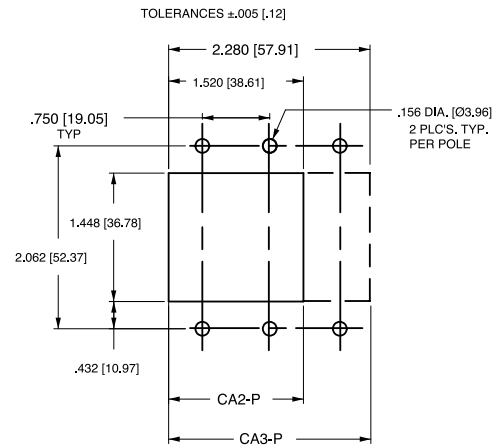

Notes:

- All dimensions are in inches [millimeters].
- Tolerance ± 0.020 [.51] unless otherwise specified.

Dimensional Specifications: in. [mm]



SCREW TYPE TERMINALS
IN SERIES TRIP CIRCUIT
CONFIGURATION SHOWN.
FOR OTHER CONFIGURATIONS
SEE CIRCUIT & TERMINAL
DIAGRAMS



PANEL CUTOUT DETAIL
TOLERANCES ±.005[.13]

Notes:

- 1 All dimensions are in inches [millimeters].
- 2 Tolerance ±.020 [.51] unless otherwise specified.

Circuit & Terminal Diagrams: in. [mm]

CIRCUIT BREAKER PROFILE	CIRCUIT SCHEMATIC		CIRCUIT CODE	AUX SWITCH CODE	CIRCUIT SCHEMATIC		CIRCUIT CODE	AUX SWITCH CODE
	ANSI	IEC			ANSI	IEC		
<p>SERIES TRIP (2 TERM'S.)</p>	<p>SWITCH ONLY (NO COIL)</p>		A	0	<p>SWITCH TRIP</p>		BC	0
<p>SERIES TRIP W/AUX. SWITCH (5 TERM'S.)</p>	<p>SWITCH ONLY (NO COIL) WITH AUXILIARY SWITCH</p>		A	2 3 4	<p>SERIES TRIP WITH AUXILIARY SWITCH</p>		BC	2 3 4
<p>SHUNT TRIP (3 TERM'S.)</p>	<p>SHUNT TRIP</p>		DE	0	<p>DUAL COIL; SERIES TRIP CURRENT COIL, SHUNT TRIP VOLTAGE COIL</p>		H	0
<p>SHUNT TRIP (4 TERM'S.)</p>	<p>RELAY TRIP</p>		FG	0	<p>DUAL COIL; SERIES TRIP CURRENT COIL, RELAY TRIP VOLTAGE COIL</p>		K	0



BARRIER FOR
UL-RECOGNIZED MULTI-POLE
BREAKERS



BARRIER FOR
UL-489 LISTED MULTI-POLE
BREAKERS

Notes:

- 1 All dimensions are in inches [millimeters].
- 2 Tolerance $\pm .020$ [.51] unless otherwise specified.
- 3 Schematic shown represents current trip circuit.

Dimensional Specifications: in. [mm]



Notes:

- 1 Dimensions apply to all variations shown. Notice that circuit breaker line and load terminal orientation on indicate OFF is opposite of indicate ON.
- 2 For pole orientation with horizontal legend, rotate front view clockwise 90°.
- 3 All dimensions are in inches [millimeters].
- 4 Tolerance ±.020 [5.1] unless otherwise specified.

Dimensional Specifications: in. [mm]

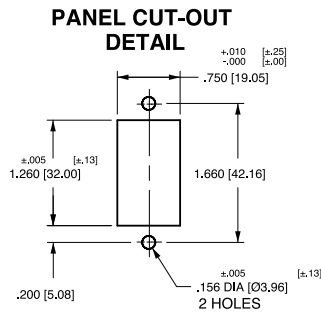
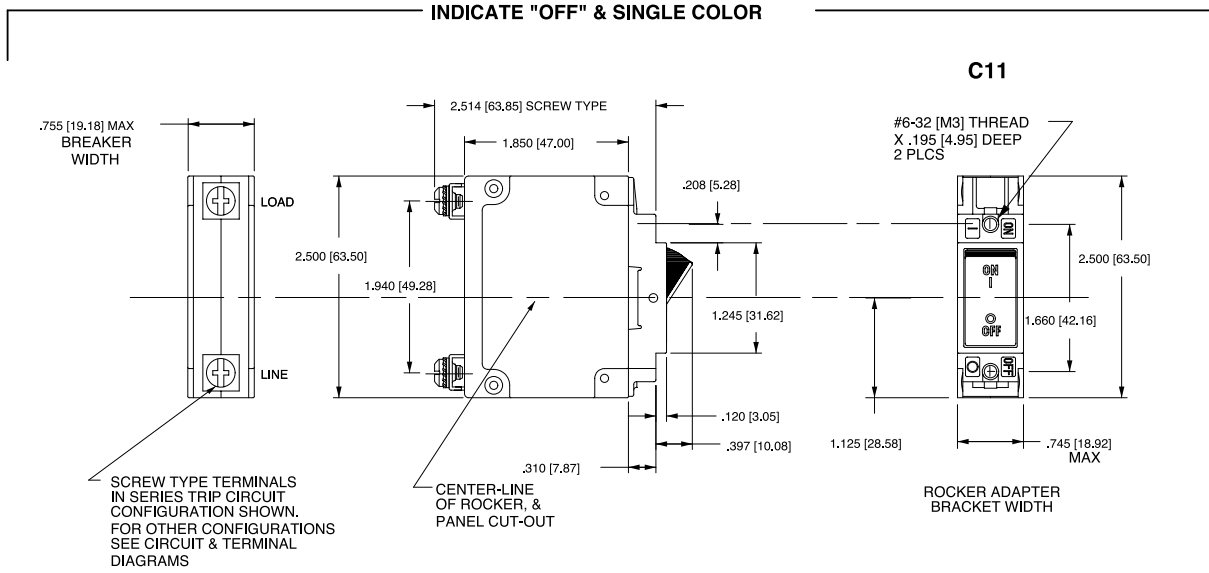

PUSH-TO-RESET ACTUATOR

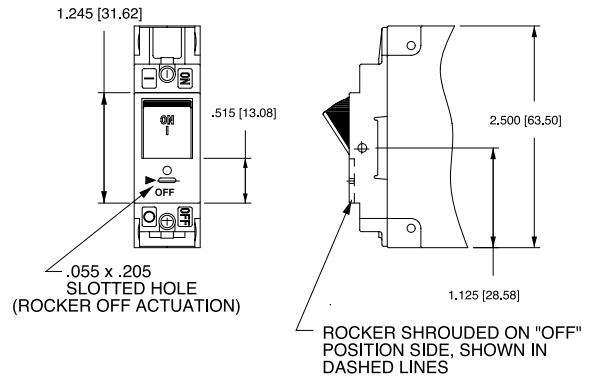

ACTUATOR SIDE VIEW (SURFACE CONTOURS)

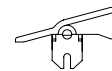
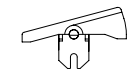

Notes:

- 1 For pole orientation with horizontal legend, rotate front view clockwise 90°.
- 2 All dimensions are in inches [millimeters].
- 3 Tolerance ±.020 [.51] unless otherwise specified.

Authorized Sales Representatives and Distributors

Click on a region of the map below to find your local representatives and distributors or visit www.carlingtech.com/findarep.



About Carling

Founded in 1920, Carling Technologies is a leading manufacturer of electrical and electronic switches and assemblies, circuit breakers, electronic controls, power distribution units, and multiplexed power distribution systems. With four ISO registered manufacturing facilities and technical sales offices worldwide, Carling Technologies Sales, Service and Engineering teams do much more than manufacture electrical components, they engineer powerful solutions! To learn more about Carling please visit www.carlingtech.com/company-profile.

To view all of Carling's environmental, quality, health & safety certifications please visit www.carlingtech.com/environmental-certifications

Worldwide Headquarters

Carling Technologies, Inc.
60 Johnson Avenue, Plainville, CT 06062
Phone: 860.793.9281 **Fax:** 860.793.9231
Email: sales@carlingtech.com

Northern Region Sales Office: nrsm@carlingtech.com
Southeast Region Sales Office: sersm@carlingtech.com
Midwest Region Sales Office: mrsm@carlingtech.com
West Region Sales Office: wrsm@carlingtech.com
Latin America Sales Office: larsm@carlingtech.com

Asia-Pacific Headquarters

Carling Technologies, Asia-Pacific Ltd.,
Suite 1607, 16/F Tower 2, The Gateway,
Harbour City, 25 Canton Road,
Tsimshatsui, Kowloon, Hong Kong
Phone: Int + 852-2737-2277 **Fax:** Int + 852-2736-9332
Email: sales@carlingtech.com.hk

Shenzhen, China: shenzhen@carlingtech.com
Shanghai, China: shanghai@carlingtech.com
Pune, India: india@carlingtech.com
Kaohsiung, Taiwan: taiwan@carlingtech.com
Yokohama, Japan: japan@carlingtech.com

Europe | Middle East | Africa Headquarters

Carling Technologies LTD
4 Airport Business Park, Exeter Airport,
Clyst Honiton, Exeter, Devon, EX5 2UL, UK
Phone: Int + 44 1392.364422 **Fax:** Int + 44 1392.364477
Email: ltd.sales@carlingtech.com

Germany: gmbh@carlingtech.com
France: sas@carlingtech.com



Carling Technologies®

Innovative Designs. Powerful Solutions.